

AMERICAN PROFESSIONAL CLASSIC HOTSHOT TELECASTER®

(011497XXX)

PARTS LAYOUT

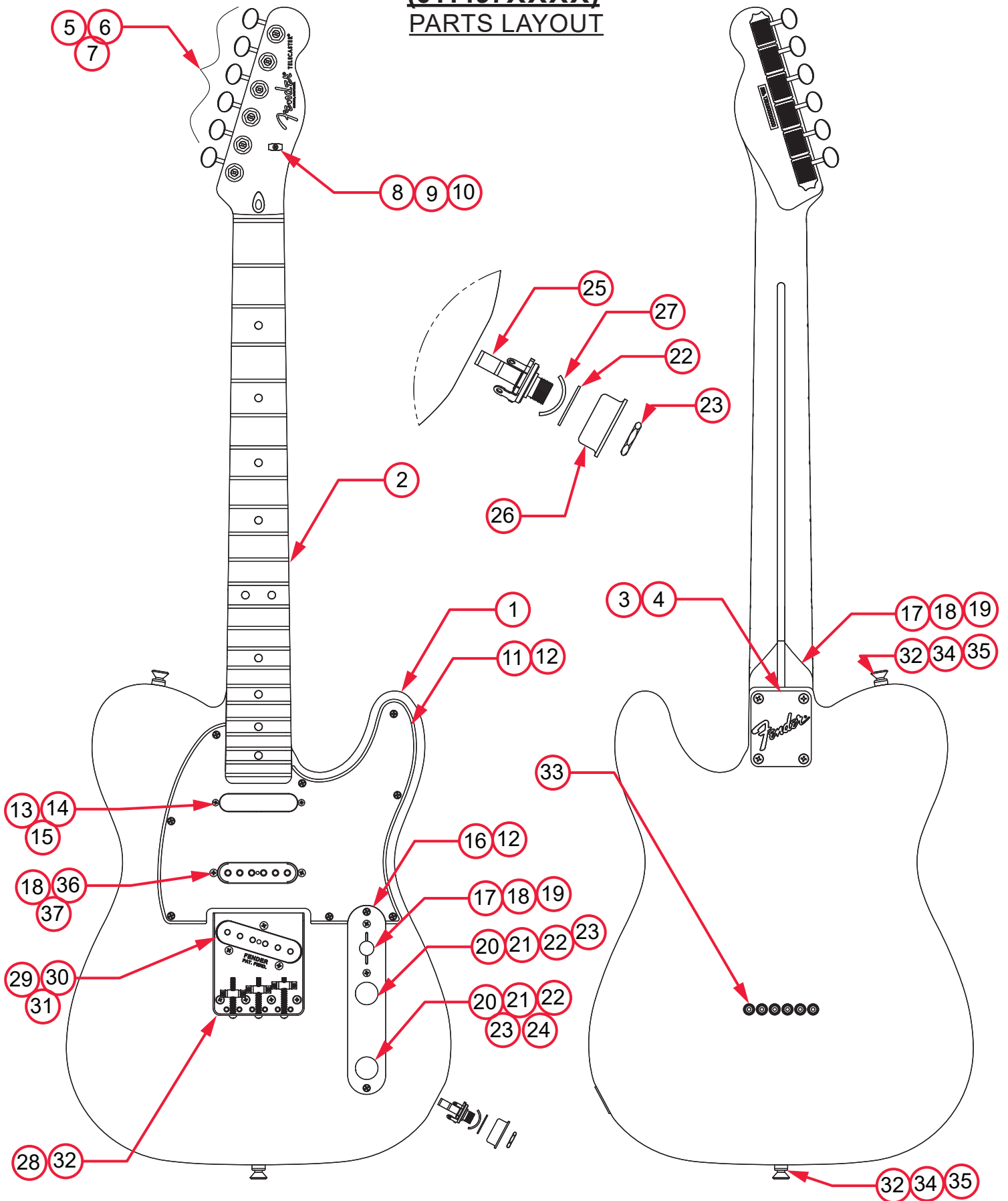

AMERICAN PROFESSIONAL CLASSIC HOTSHOT TELECASTER®

(011497XXX)

PARTS LIST

REF#	DESCRIPTION	PART NUMBER
1	BODY AM PRO CLSC TELE FSGM	7730189574
1	BODY AM PRO CLSC TELE FLPB	7730189579
1	BODY AM PRO CLSC TELE BTB	7730190550
1	BODY AM PRO CLSC TELE 3TS	7730190500
2	NECK ASSY AM PRO CLSC TELE MPL	7730192000
2	NECK ASSY AM PRO CLSC TELE RW	7730191000
3	PLATE NECK STD SERIES LOGO NO TILT	0048691000
4	SCREW SMA 8 x 1-3/4 OHP NI	0015636049
5	TUNING KEYS CLASSIC GEAR STAGGERED SET	7718967000
6	WASHERS KEY	0053106049
7	BUSHINGS KEY	0058820049
8	STRING TREE VINTAGE NI	0093569000
9	SPACER STRING TREE 65 STRAT NYLON	0093999000
10	SCREW SMA #3 X 5/8 RHP STL NI	0011358049
11	PICKGUARD NASHVILLE TELE B/W/B KR	7731240000
11	PICKGUARD NASHVILLE TELE BRN SHL KR	7720728000
11	PICKGUARD NASHVILLE .06 BLK KR	7731827000
12	SCREW SMAB 4 X 1/2 OHP NI	0015578049
13	PICKUP ASSY AM PRO CLSC TELE NECK	7730154000
14	TUBING LATEX CUT 1/8 X 1/4 X .550	0039410000
15	SCREW MACHINE 4-40 X 7/8 RHP STL NI	7700222000
16	TELE CONTROL PLATE ALUM CHR	0093823000
17	SWITCH 5-WAY LEVER	0991367000
18	SCREW MA 6-32X5/8 RH NI	0994925000
19	KNOB SWITCH TELE W/ NYLON INSERT BLACK	7728973000
20	CONTROL SOSH 250K A-TAPE .25B .625S	0990831000
21	KNOB DIAMOND KNURL 52 TELE UPG BRASS CHR	0094040049
22	WASHER LOCKING INTL 3/8 X .687 X .035 NI	0016436049
23	NUT HEX 3/8-32x3/32 TK NI	0016352049
24	PCB ASSY GREASE BUCKET TONE CIRCUIT	7713546000
25	OUTPUT JACK OPEN CIRCUIT 11	0047329049
26	FERRULE JACK TELE CHROME	0021452000
27	RETAINER JACK NI PLT (TELE)	0010355069

*= NOT PICTURED IN DIAGRAM



AMERICAN PROFESSIONAL CLASSIC HOTSHOT TELECASTER®

(011497XXX)

SWITCH AND CONTROL FUNCTION

5 WAY SWITCH POSITION					SWITCH POSITION
5	4	3	2	1	
					← NECK PICKUP (A)
					← MIDDLE PICKUP (B)
					← BRIDGE PICKUP (C)
	PICKUP IS ON				 INDICATES POSITION OF 5 WAY SWITCH
	PICKUP IS OFF				

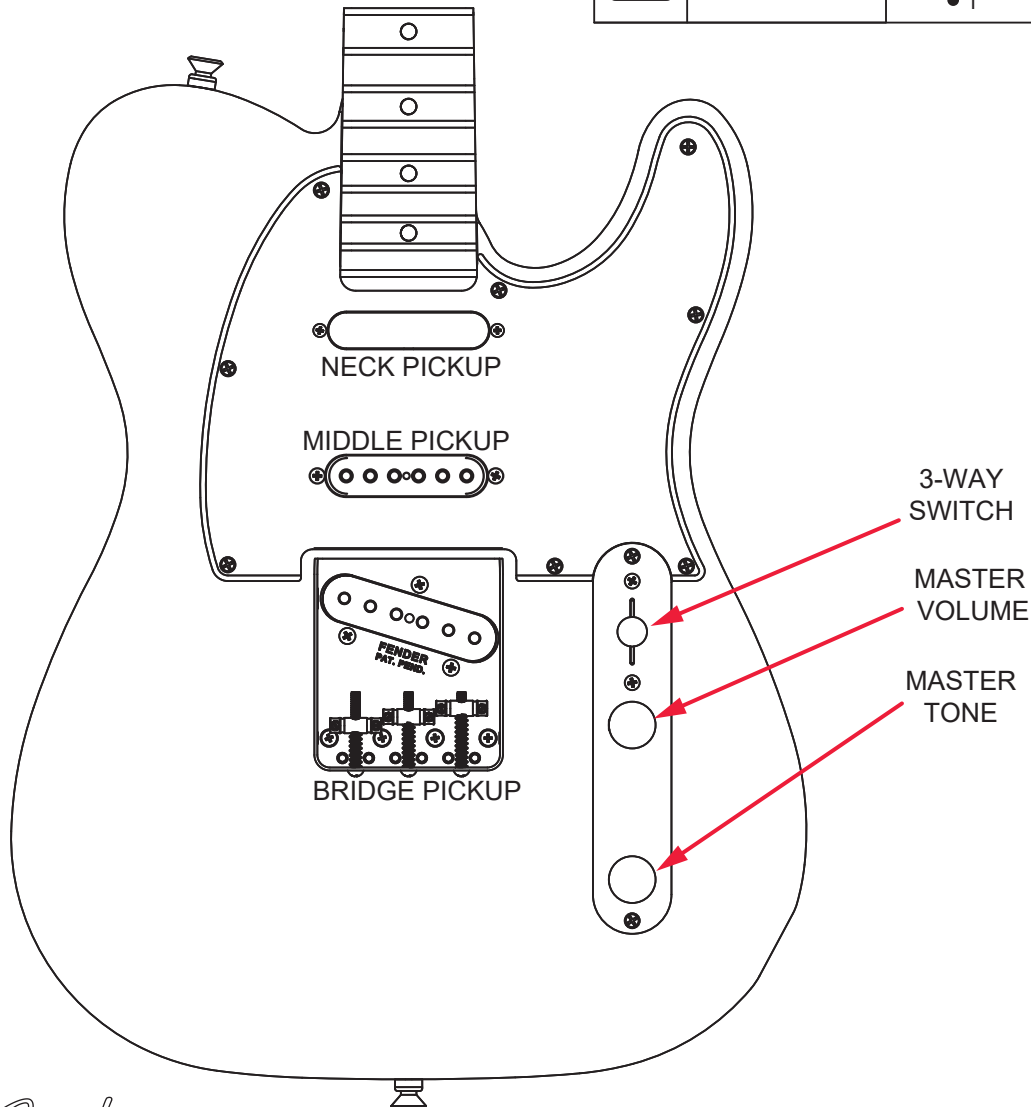

AMERICAN PROFESSIONAL CLASSIC HOTSHOT TELECASTER®

(011497XXX)

ADDITIONAL SPECIFICATION DETAIL

FRET SIZE: MEDIUM JUMBO
(FRET DIMENSIONS ARE BEFORE INSTALLATION)

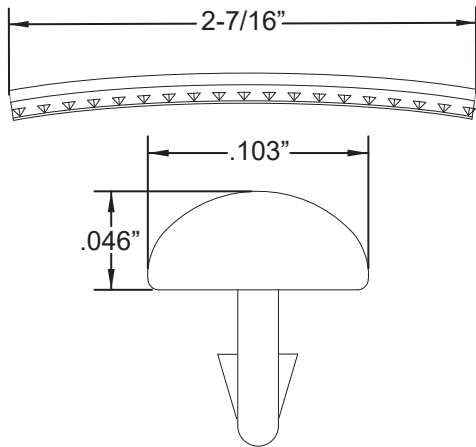

PLEASE NOTE: AS EACH NECK IS SANDED & FINISHED BY HAND, THICKNESS DIMENSIONS MAY VARY SLIGHTLY FROM THOSE SHOWN.

NECK PROFILE: MODERN "C"

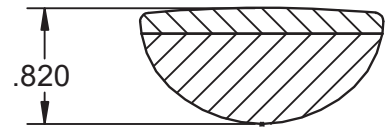

1ST FRET PROFILE

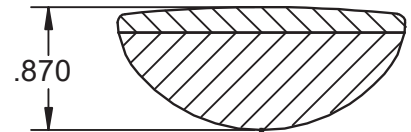

12TH FRET PROFILE

TUNING MACHINES : P/N 7718967000
OUTER SHAFT DIAMETER .394"

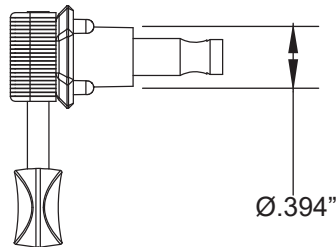

TUNING MACHINE THRU-HOLE
INNER DIAMETER .404"

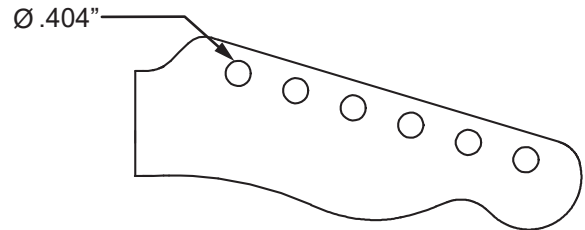

SADDLE HEIGHT SCREWS:

7/16" : P/N 0016105049

3/8" : P/N 0094038000

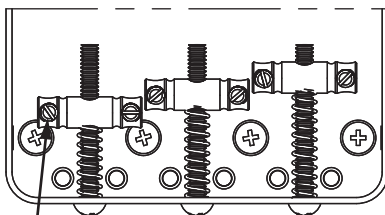

SET SCREW

TRUSS ROD NUT P/N 0994943000
TRUSS ROD ADJUSTMENT WRENCH:
1/8" HEX KEY P/N 0023811049

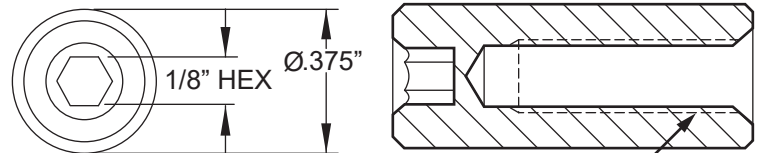

10-32
THREAD

LOGO: AM PRO CLASSIC TELECASTER
APPLIED UNDER THE FINISH



PICKUP SPECIFICATIONS

POSITION	MAGNETS	DC RESISTANCE	POLARITY
NECK	ALNICO 5 BEVELED	7.67 - 8.14KΩ	SOUTH
MIDDLE	ALNICO 5 BEVELED	6.06 - 6.43KΩ	NORTH
BRIDGE	ALNICO 5 BEVELED	6.44 - 6.84KΩ	SOUTH