

# LINCOLN BREWSTER STRATOCASTER® (0116502778)

## PARTS LAYOUT

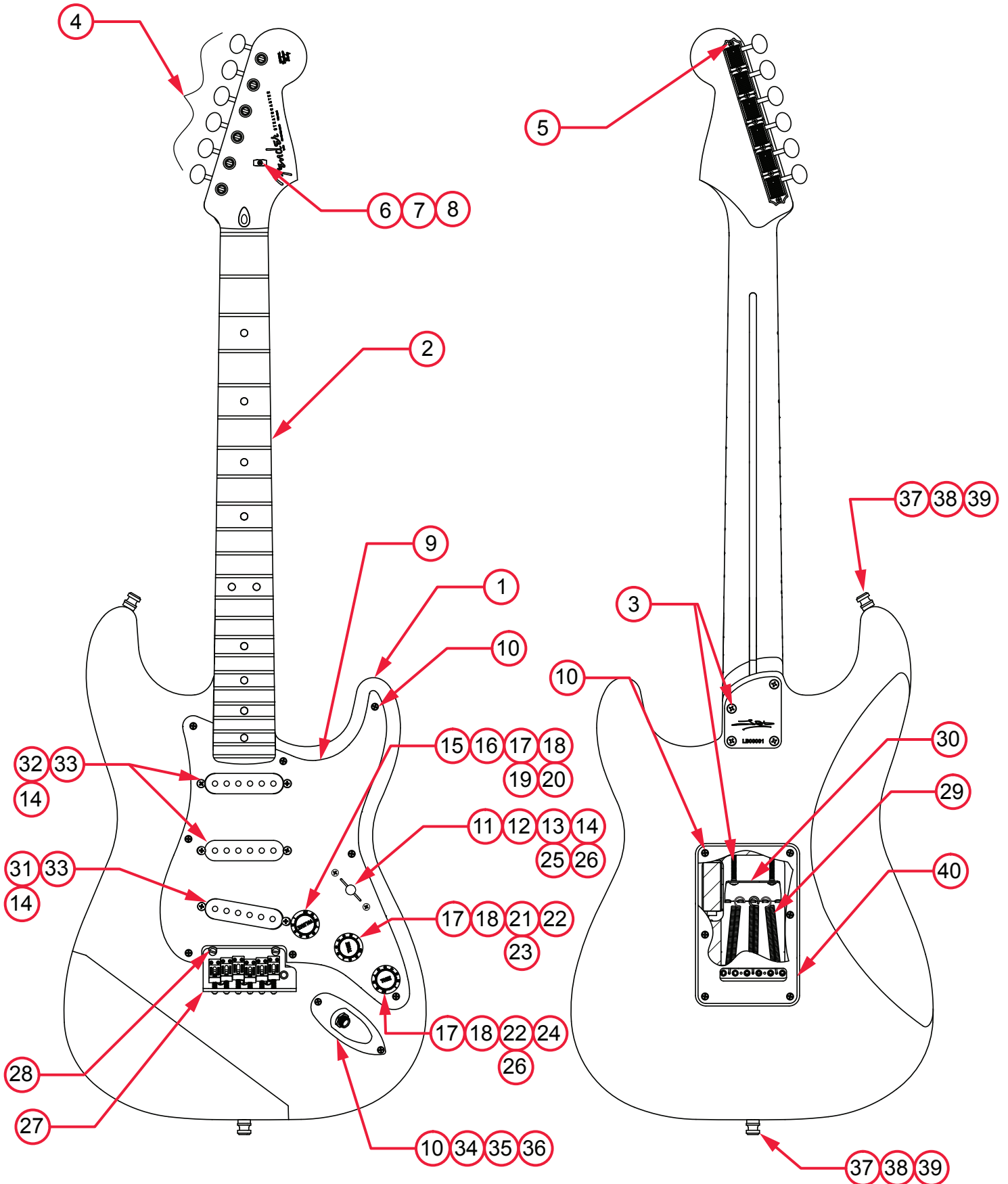

# LINCOLN BREWSTER STRATOCASTER® (0116502778)

## PARTS LIST

REF#	DESCRIPTION	PART NUMBER
1	BODY LINCOLN BREWSTER STRAT AZG	7712752578
2	NECK ASSY LINCOLN BREWSTER STRAT MPL	7711807000
3	SCREW SMA 8 X 1-3/4 RHP STL NI	0015636049
4	VINTAGE TUNNING KEYS LOCKING W/HDWR	0072272049
5	SCREW SMAB 3 X 3/8 RHP STL NI	0011357049
6	STRING TREE VINTAGE NI W/HDWR	0994910000
7	SPACER STRING TREE 62 STRAT	0020423000
8	SCREW SMA #3 X 5/8 RHP STL NI	0011358049
9	PICKGUARD VINT 57 STRAT EGGSHELL W/SHIELD	7700224000
10	SCREW SMAB 4 X 1/2 OHP NI	0015578049
11	SHIELD PICKGUARD 57 VINTAGE STRAT	0019640000
12	SWITCH 5-WAY LEVER W/HDWR	0991367000
13	KNOB LEVER SWITCH AGED WHITE	0994938000
14	SCREW M 6-32 X 3/4 OHP NI	0029483000
15	POT SWITCH SPLIT SHAFT PUSH PULL 250K	0992257000
16	SOLDER LUG 3/8	0027887000
17	NUT HEX 3/8-32 X 3/32 TK NI	0016352049
18	KNOBS STRAT AGED WHITE (1) VOL (2) TONE	0991369000
19	CAPACITOR DISC 500V 10% 560pF	0051459000
20	RESISTOR CF 1/4W 5% 300K	0028016000
21	PCB ASSY LINCOLN BREWSTER	7714329000
22	WASHER INTL LOCK .035" X 3/8 NI	0056790000
23	BATTERY PLUG 9 VOLT	0017458000
24	CONTROL 250K 10% TPR SPLIT	0990830000
25	RESISTOR CF 1/4W 5% 220K	0025059000
26	CAPACITOR MPF RDL .022µF 250V 10%	0024832049
27	BRIDGE ASSY AM PRO STRAT	7709950000
27A	BRIDGE PLATE TREM AM PRO STRAT CHROME	7709899000
27B	BLOCK TREMOLO AM DLX STRAT RH SILVER MET	0077090000
27C	BRIDGE SECTION ASSY NI AS STRAT SHORT	0075123101
27D	BRIDGE SECTION ASSY NI AS STRAT TALL	0075123102
27E	SPRING BRIDGE #1932	0019281049
27F	SCREW M 4-40 X 5/8 RHP NI	0015693049
27G	SCREW M 8-32 X 3/8 FHP NI	0019656049
27H	SPRING CLIP ULTRA	0036531000
27I	BUSHING NYL NAT .31 OD X .191 ID X .87 L	7710005000

\*= NOT PICTURED IN DIAGRAM





# LINCOLN BREWSTER STRATOCASTER® (0116502778)

## WIRING ASSEMBLY

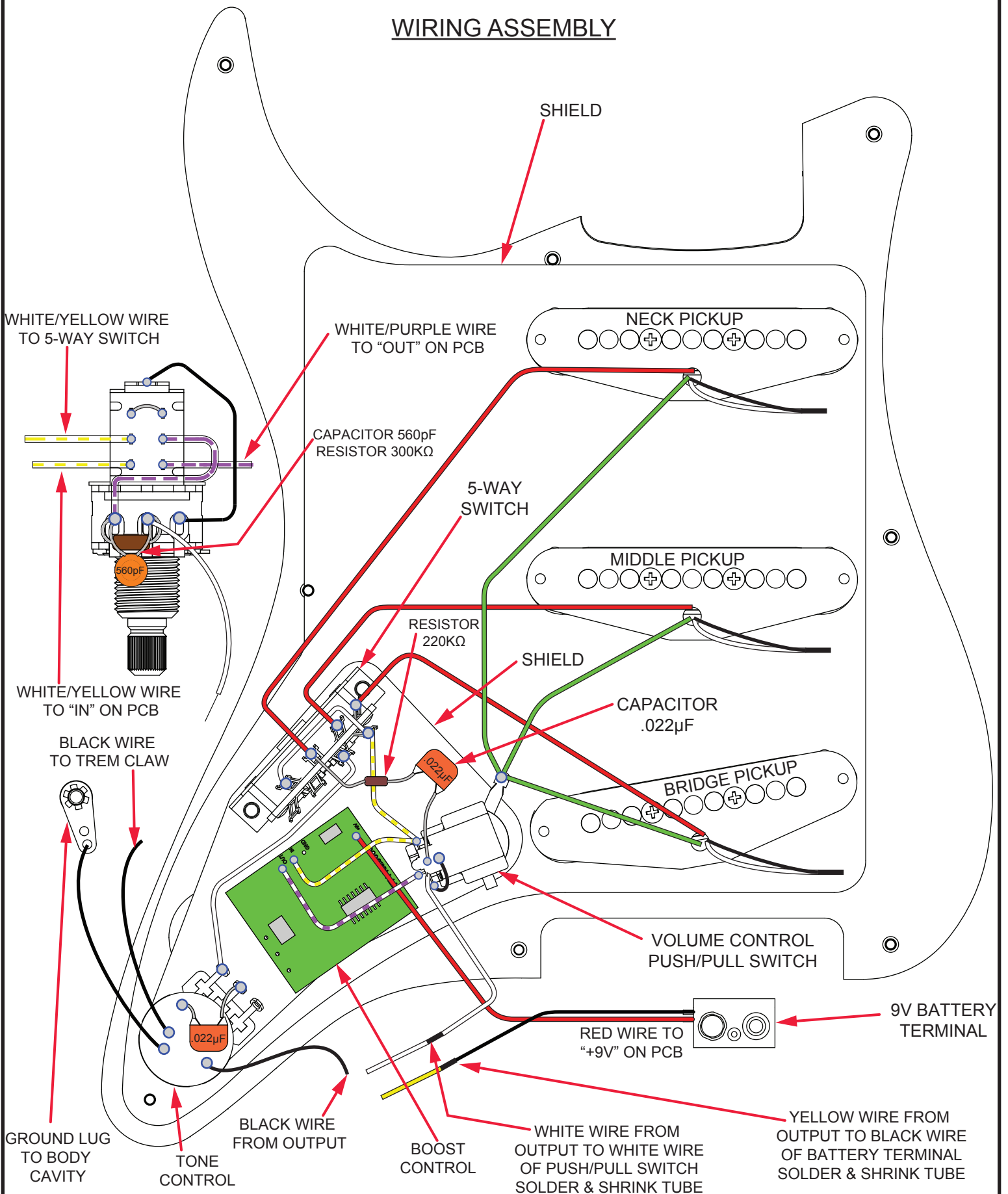

# LINCOLN BREWSTER STRATOCASTER® (0116502778)

## SWITCH AND CONTROL FUNCTION

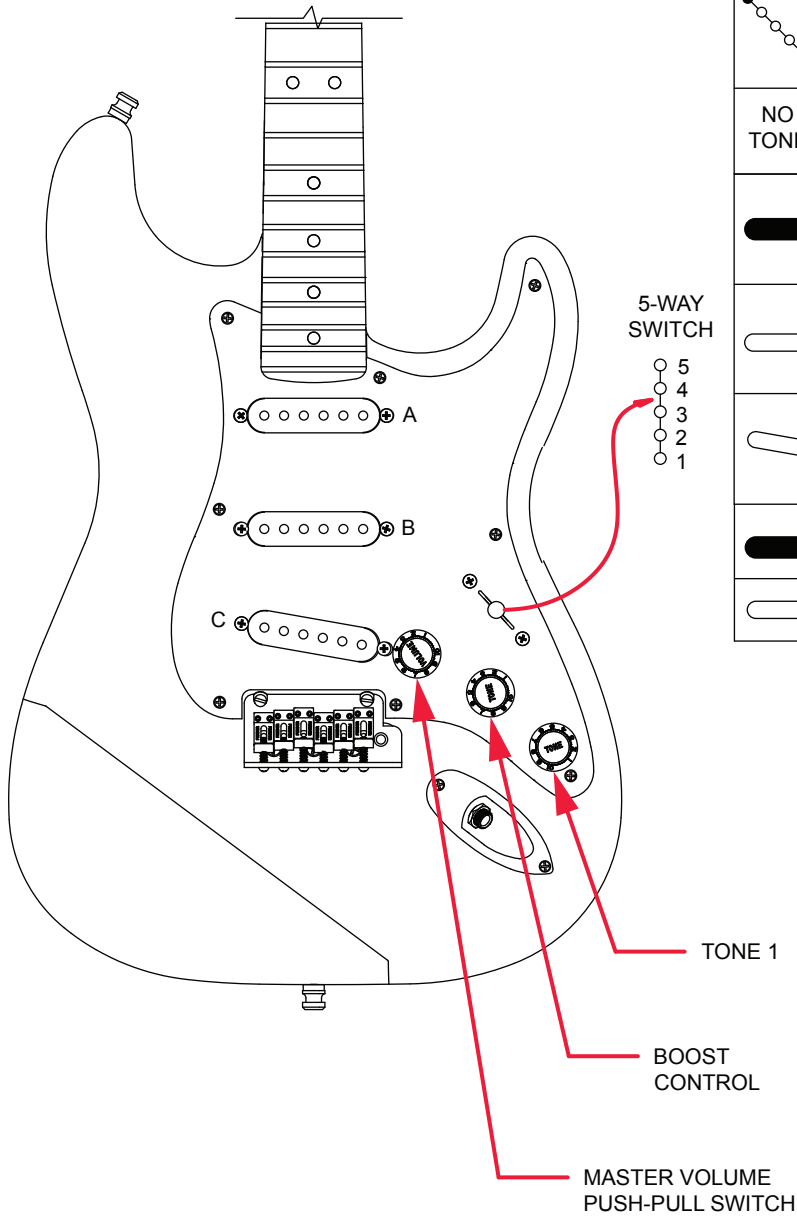

5-WAY SWITCH POSITION					SWITCH POSITION
					SWITCH POSITION
NO TONE	NO TONE	NO TONE	TONE 1	TONE 1	TONE CONTROL
					← NECK PICKUP (A)
					← MIDDLE PICKUP (B)
					← BRIDGE PICKUP (C)
	PICKUP IS ON		INDICATES POSITION OF 5 WAY SWITCH		
	PICKUP IS OFF				

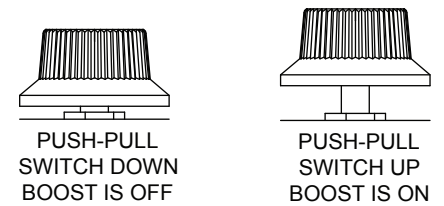

WHEN OFF CONTROL IS NOT USED

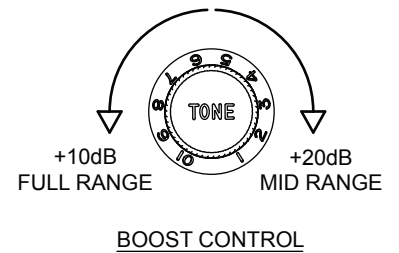

# LINCOLN BREWSTER STRATOCASTER® (0116502778)

## ADDITIONAL SPECIFICATION DETAIL

**FRET SIZE: MEDIUM JUMBO**  
(FRET DIMENSIONS ARE BEFORE INSTALLATION)

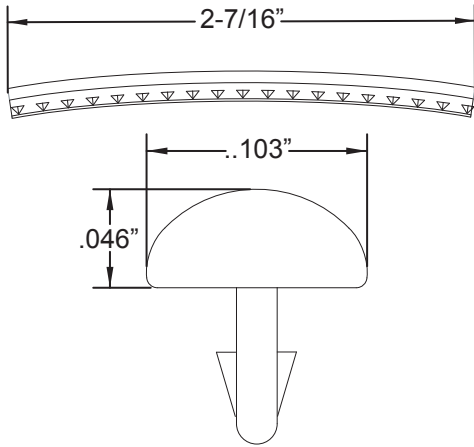

PLEASE NOTE: AS EACH NECK IS SANDED & FINISHED BY HAND, THICKNESS DIMENSIONS MAY VARY SLIGHTLY FROM THOSE SHOWN.

**NECK PROFILE: SOFT "V"**

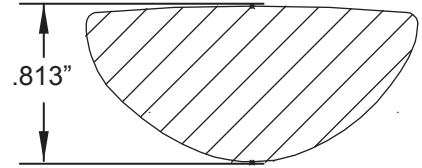

**1ST FRET PROFILE**

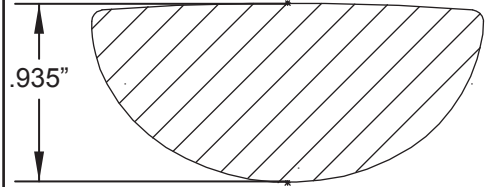

**12TH FRET PROFILE**

**STAGGERED TUNING MACHINE SET W/HDW P/N 0072272049**

**OUTER SHAFT DIAMETER ."**

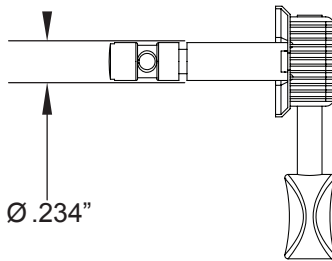

**TUNING MACHINE THRU-HOLE**

**INNER DIAMETER .358"**

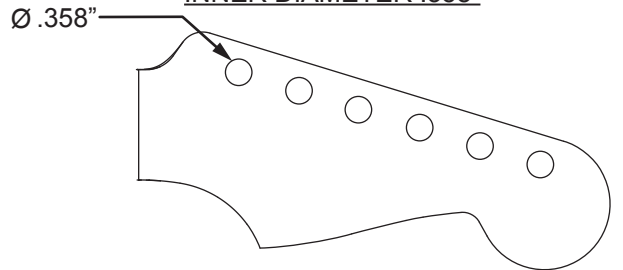

**SADDLE HEIGHT ADJUSTMENT WRENCH:**

**.050" HEX KEY P/N 0018531049**

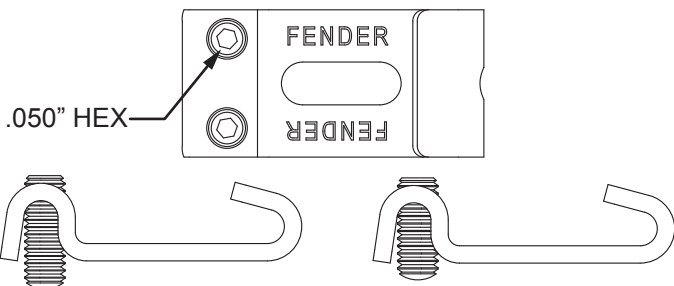

**SADDLE HEIGHT ADJUSTMENT SCREWS:**

TALL: P/N 0075384000      SHORT: P/N 0075536000

**TRUSS ROD NUT P/N 0994943000**

**TRUSS ROD ADJUSTMENT WRENCH:**

**1/8" HEX KEY P/N 0023811049**

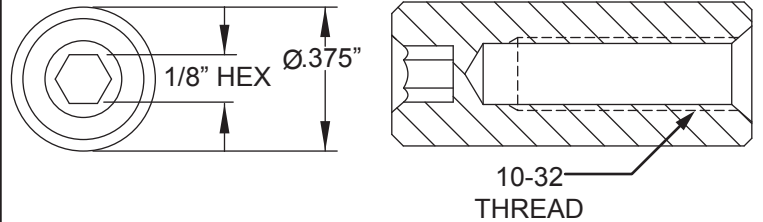

**LOGO: VINTAGE STRATOCASTER & ORIGINAL CONTOUR BODY**  
**APPLIED OVER THE FINISH**



### PICKUP SPECIFICATIONS

POSITION	MAGNETS	DC RESISTANCE	POLARITY
NECK	ALNICO 2 BEVELED	5.8 - 6.4KΩ	SOUTH
MIDDLE	ALNICO 2 BEVELED	5.8 - 6.4KΩ	SOUTH
BRIDGE	ALNICO 2 BEVELED	6.1 - 6.7KΩ	SOUTH