

AMERICAN ULTRA LUXE VINTAGE 60'S STRATOCASTER HSS

(0118230XXX)

PARTS LAYOUT

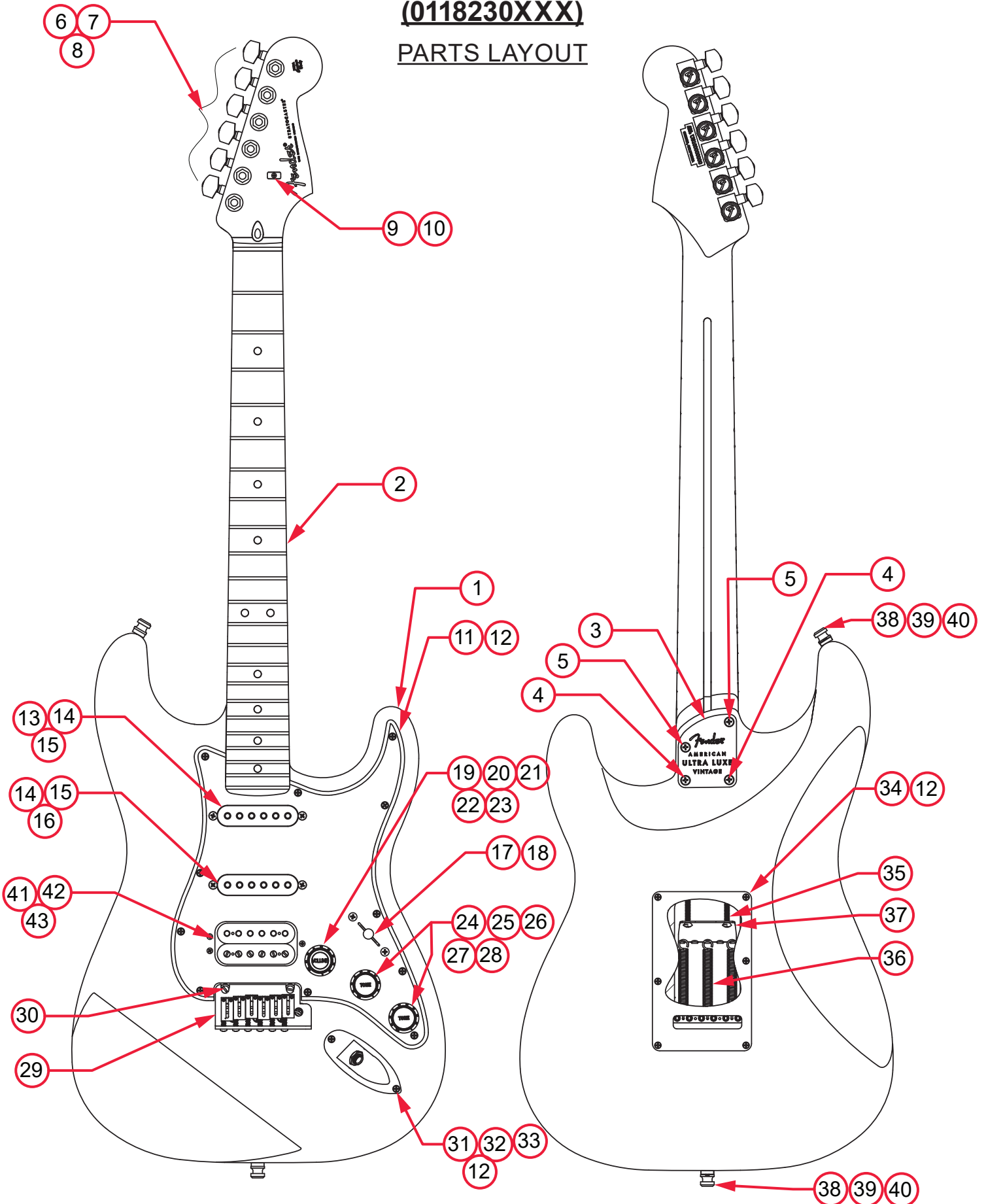

AMERICAN ULTRA LUXE VINTAGE 60'S STRATOCASTER HSS (0118230XXX)

PARTS LIST





















REF#	DESCRIPTION	PART NUMBER
1	BODY AM ULTRA LUX VINT STRAT ALD FRD	7729863540
1	BODY AM ULTRA LUX VINT STRAT ALD SFMG	7729863549
2	NECK ASSY UTRA LUX VINT 61 STRAT RW	7729669000
3	NECK PLATE GTR AM ULTRA LUX VINT HRLM	7730317300
4	SCREW SMA 8 X 1-1/2 OHP STL NI HRLM	7716272300
5	SCREW SMA 8 X 1-1/4 OHP STL NI HRLM	0072900300
6	KEY LOCKING SHORT POST HRLM	7728723300
7	WASHER KEY CHR HRLM	0053106300
8	BUSHING KEY CHR HRLM	0053107300
9	STRING TREE AM ELITE GTR CHR HRLM	7708381300
10	SCREW SMA 2 X 9/16 FHP NI HRLM	0051621300
11	PICKGUARD AM STD STRAT HSS MG HRLM	0054021300
12	SCREW SMAB 4 X 1/2 OHP NI HRLM	0015578300
13	PICKUP ASSY VINT II 61 STRAT AW HRLM	7721671300
14	TUBING LATEX CUT .250OD X .125ID X .300L	0994916000
15	SCREW MACH 6-32 X 5/8 OHP NI HRLM	0015776300
16	PICKUP ASSY VINT II 61 STRAT RWRP AW HRLM	7729543300
17	SWITCH 5-WAY LEVER DISCRETE/COM	0078776049
18	KNOB LEVER SWITCH AGED WHT HRLM	0053765300
19	SW/POT ASSY S-1 250K .25B SPSH W/HDWR	0078777000
20	PCB ASSY TREBLE BLEED AM PRO STRAT/TELE	7711092000
21	KNOB STRAT SOFT OVERMOLD SPSH AW HRLM	7708070300
22	SWITCH CAP STRAT SPSH VOLUME HRLM	0059266330
23	2-PIN MALE LOCKING QUICK CONNECT BW 4"	7717591000
24	CONTROL 250K 10% TAPER SPSH	0078779000
25	NUT HEX 3/8-32 X 3/32 TK NI	0016352049
26	WASHER LOCKING INTL 3/8 X .687 X .035 NI	0016436049
27	CAPACITOR ORANGE DROP .022uF 100V 5%	7727719000
28	KNOB STRAT SOFT OVERMOLD TONE AW HRLM	7708072300
29	BRIDGE ASSY AM ULTRA LUX VINT STRAT HRLM	7730298300
29A	BRIDGE PLATE ULTRA STRAT TREM HRLM	0036527300
29B	BRIDGE BLOCK AM ULTRA II STRAT CRS RH	7728836000
29C	BRIDGE SADDLE AM STD STRAT POL HRLM	0036528300
29D	SCREW MACH 8-32 X 3/8 FHP NI	0019656049
29E	SET SCREW 4-40 X 1/4 HEX CUP STL BLX	0026779049





















*= NOT PICTURED IN DIAGRAM





AMERICAN ULTRA LUXE VINTAGE 60'S STRATOCASTER HSS (0118230XXX)

SWITCH AND CONTROL FUNCTION

TONE CONTROL	T1 ONLY	T1 ONLY	T1 ONLY	T1 ONLY	T2 ONLY	
5 WAY SELECTOR POSITION						S-1 SWITCH OFF (UP POSITION)
NECK P/U						COMBINED PICKUPS ARE IN PARALLEL
MIDDLE P/U						
BRIDGE P/U						

TONE CONTROL	T1 ONLY	T1 ONLY	T1 ONLY	T1 ONLY	T2 ONLY	
5 WAY SELECTOR POSITION						S-1 SWITCH ON (DOWN POSITION)
NECK P/U						COMBINED PICKUPS ARE IN PARALLEL
MIDDLE P/U						
BRIDGE P/U						

 PICKUP IS ON
  PICKUP IS OFF

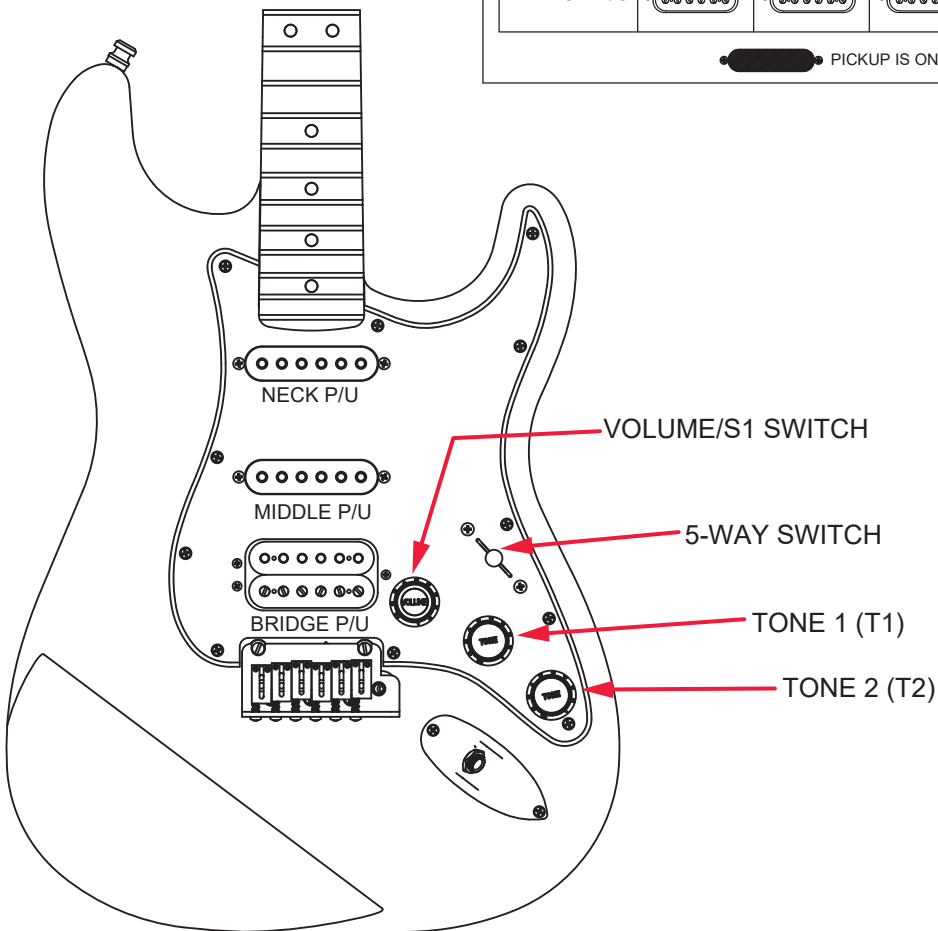

AMERICAN ULTRA LUXE VINTAGE 60'S STRATOCASTER HSS (0118230XXX)

ADDITIONAL SPECIFICATION DETAIL

FRET SIZE: MEDIUM JUMBO
(FRET DIMENSIONS ARE BEFORE INSTALLATION)

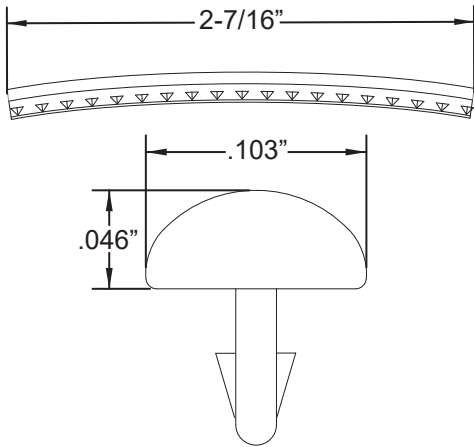

PLEASE NOTE: AS EACH NECK IS SANDED & FINISHED BY HAND, THICKNESS DIMENSIONS MAY VARY SLIGHTLY FROM THOSE SHOWN.

NECK PROFILE: MODERN "D"

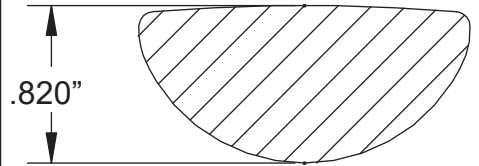

1ST FRET PROFILE

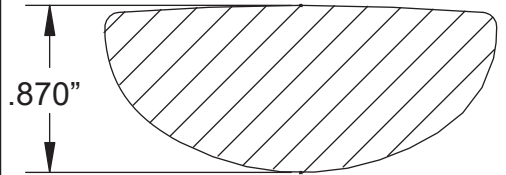

12TH FRET PROFILE

TUNING MACHINES : P/N 7728723300
OUTER SHAFT DIAMETER .394"

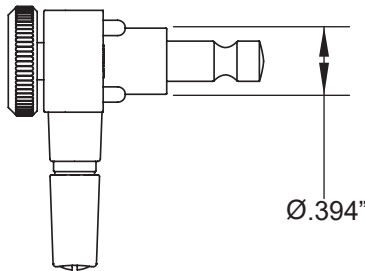

TUNING MACHINE THRU-HOLE
INNER DIAMETER .404"

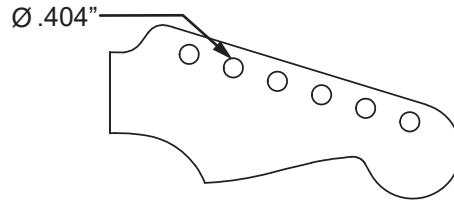

SADDLE HEIGHT ADJUSTMENT WRENCH:
.050" HEX KEY P/N 0018531049

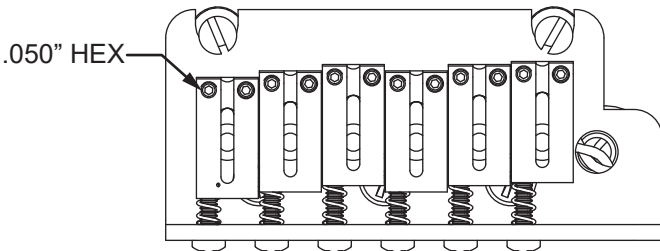

SADDLE HEIGHT ADJUSTMENT SCREWS:

TALL: P/N 0026780049 SHORT: P/N 0026779049

TRUSS ROD NUT P/N 0994943000
TRUSS ROD ADJUSTMENT WRENCH:
1/8" HEX KEY P/N 0023811049

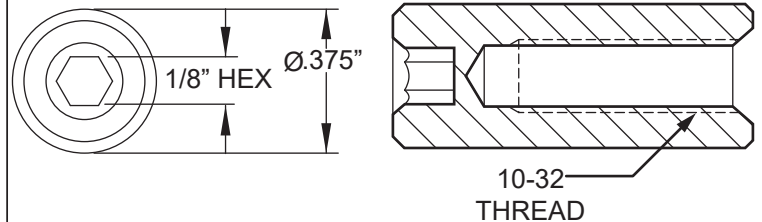

LOGO: AMERICAN ULTRA LUXE VINTAGE STRAT
APPLIED OVER THE FINISH



PICKUP SPECIFICATIONS

POSITION	MAGNETS	DC RESISTANCE	POLARITY
NECK	ALNICO 5 BEVELED	5.61 - 6.20KΩ	SOUTH
MIDDLE	ALNICO 5 BEVELED	5.61 - 6.20KΩ	NORTH
BRIDGE	ALNICO 5 BAR	7.62 - 8.10KΩ	SOUTH NORTH

