

AMERICAN ULTRA LUXE VINTAGE 60'S TELECASTER® (0118250XXX)

PARTS LAYOUT

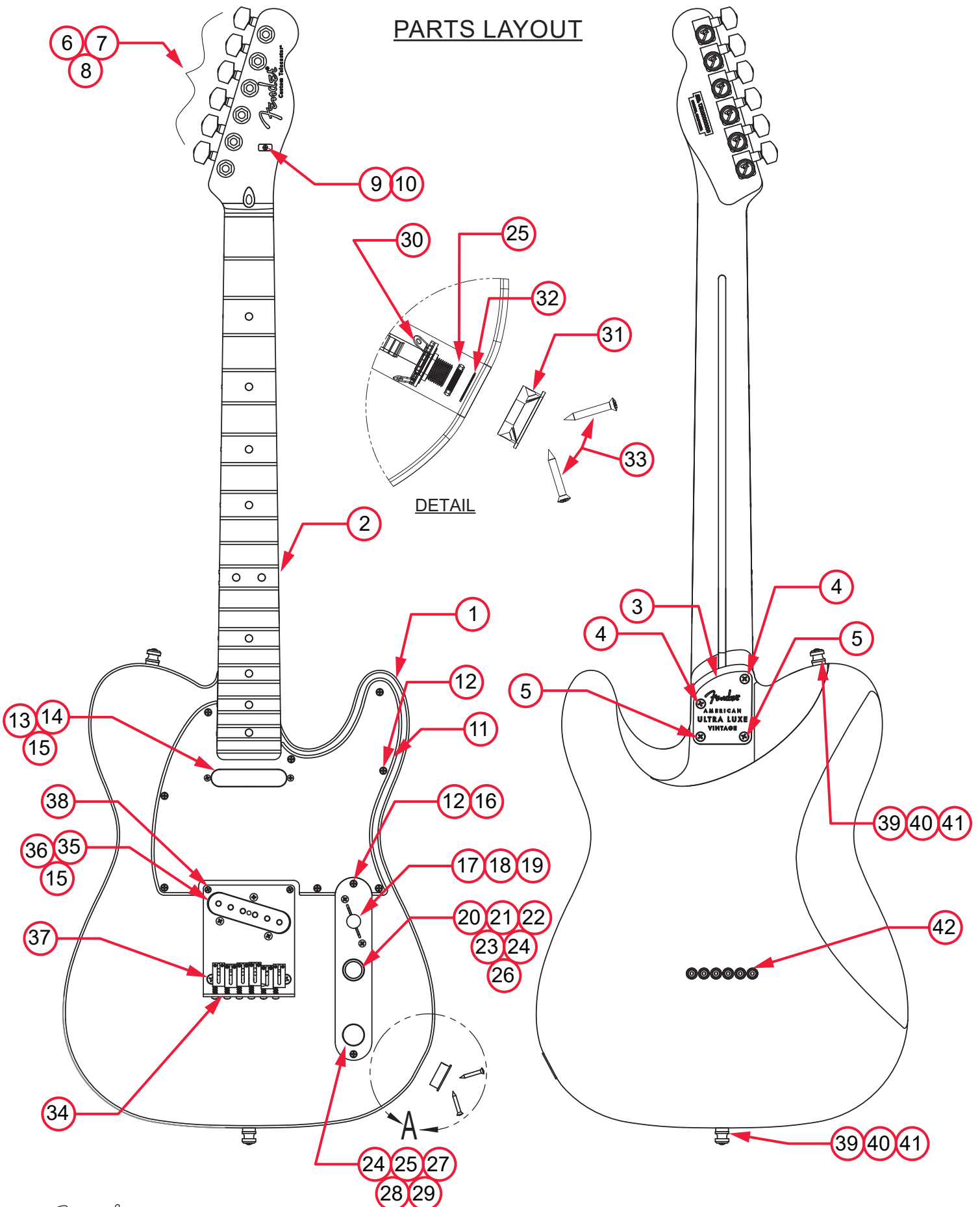

AMERICAN ULTRA LUXE VINTAGE 60'S TELECASTER® (0118250XXX)

PARTS LIST

REF#	DESCRIPTION	PART NUMBER
1	BODY AM ULTRA LUX VINT 60S TELE ALD LPB HRLM	7729585502
1	BODY AM ULTRA LUX VINT 60S TELE ALD 3TSB HRLM	7729586500
2	NECK ASSY AM ULTRA LUX VINT 60S TELE RW HRLM	7729587000
3	NECK PLATE GUITAR AM ULTRA LUX VINT HRLM	7730317300
4	SCREW SMA 8 X 1-1/4 OHP NI HRLM	0072900300
5	SCREW SMA 8 X 1-1/2 OHP NI HRLM	7716272300
6	KEY LOCKING SHORT POST	7728723300
7	WASHER KEY CHR HRLM	0053106300
8	BUSHING KEY CHRM HRLM	0053107300
9	STRING TREE AM ELITE GTR CHR HRLM	7708381300
10	SCREW SMA 2 X 9/16 FHP NI HRLM	0051621300
11	PICKGUARD AM STD TELE MG/B/MG SHLD HRLM	7729589300
12	SCREW SMAB 4 X 1/2 OHP NI HRLM	0015578300
13	PICKUP VINT II 63 TELE NK RW RP HRLM	7729545300
14	TUBING SILICONE RUBBER .500 RED	0063398000
15	SCREW MACH 4-40 X 7/8 RHP STL NI HRLM	7700222300
16	CONTROL PLATE TELE ANGLE SWITCH CHR HRLM	7719173300
17	SWITCH 3-WAY LEVER	0992041000
18	SCREW MACH 6-32 X 5/8 RH NI HRLM	0021417300
19	KNOB SWITCH TELE NYLON INSERT BLK HRLM	7728973300
20	SW/POT ASSY S-1 250K .25B SOSH	0078979000
21	COUPLING SLEEVE SOSH .320	0059278049
22	TELE/P-BASS SWITCH CAP CHR HRLM	0059270300
23	TELE/P-BASS SW KNOB HEAVY KNURL CHR HRLM	0096224300
24	WASHER LOCKING INTL 3/8 X .687 X .035 NI	0016436049
25	NUT HEX 3/8-32 X 3/32 TK NI	0016352049
26	PCB ASSY TRB BLEED AM PRO STRAT/TELE	7711092000
27	CONTROL 250K 10% TAPER SOSH	0078781000
28	KNOB HEAVY DIAMOND KNURL CHR HRLM	0096227300
29	CAPACITOR ORANGE DROP .022uF 100V 5%	7727719000
30	JACK PHONE OPEN CIRCUIT 11	0021956049
31	ELECTROSOCKET CHR HRLM	0076007300
32	WASHER LOCKING INTL 3/8 X .500 X .020 NI	0022384049
33	SCREW SMAB 5 X 1 OHP STL NI HRLM	0056156300

*= NOT PICTURED IN DIAGRAM



AMERICAN ULTRA LUXE VINTAGE 60'S TELECASTER® (0118250XXX)

WIRING ASSEMBLY

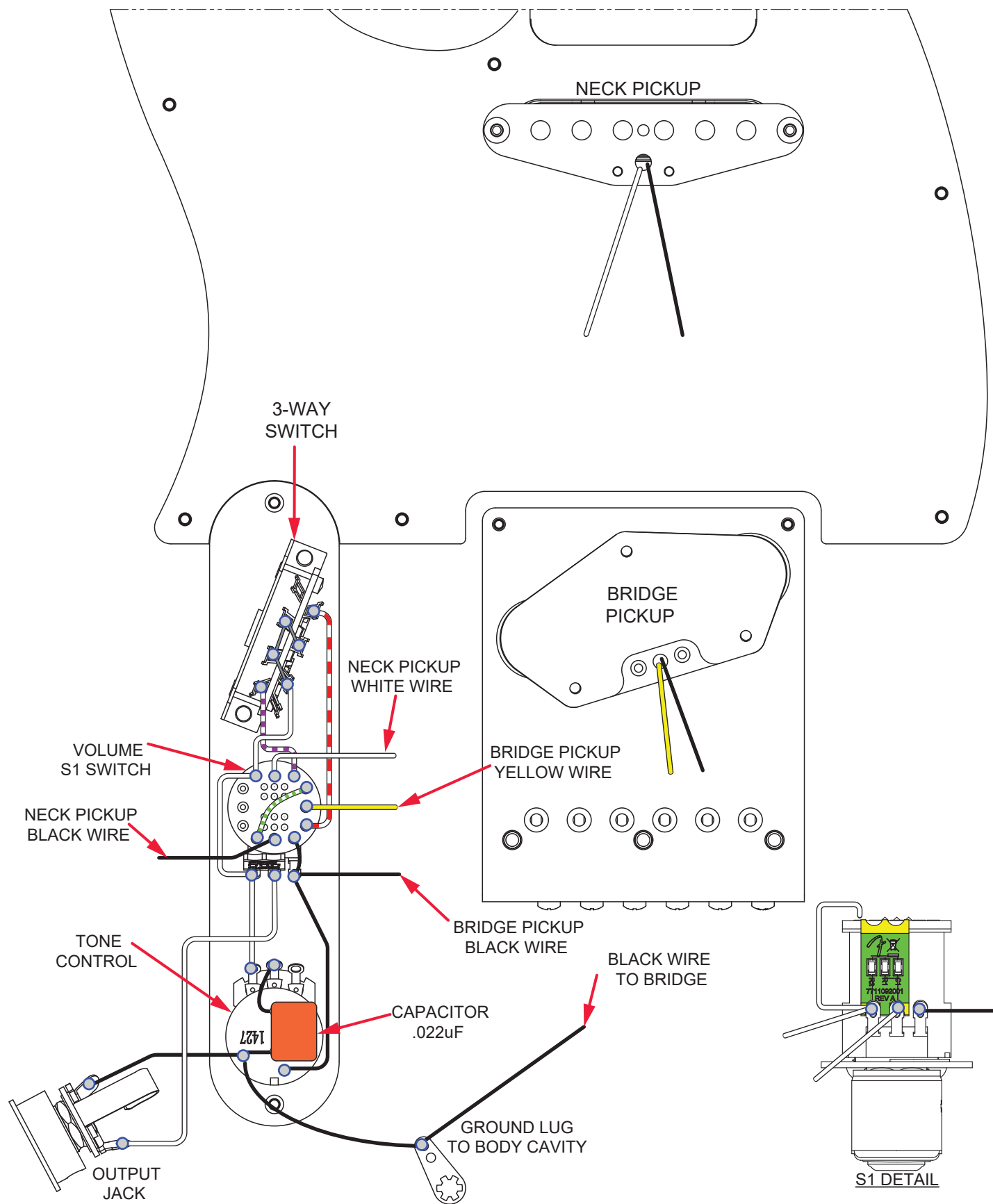

AMERICAN ULTRA LUXE VINTAGE 60'S TELECASTER® (0118250XXX)

SWITCH AND CONTROL FUNCTION

3 WAY SWITCH POSITION, S-1 OFF			
			3 WAY SWITCH
			NECK PICKUP
	 IN PARALLEL		BRIDGE PICKUP

3 WAY SWITCH BYPASSED, S-1 ON	
	NECK PICKUP
 IN SERIES	BRIDGE PICKUP

	PICKUP IS ON
	PICKUP IS OFF

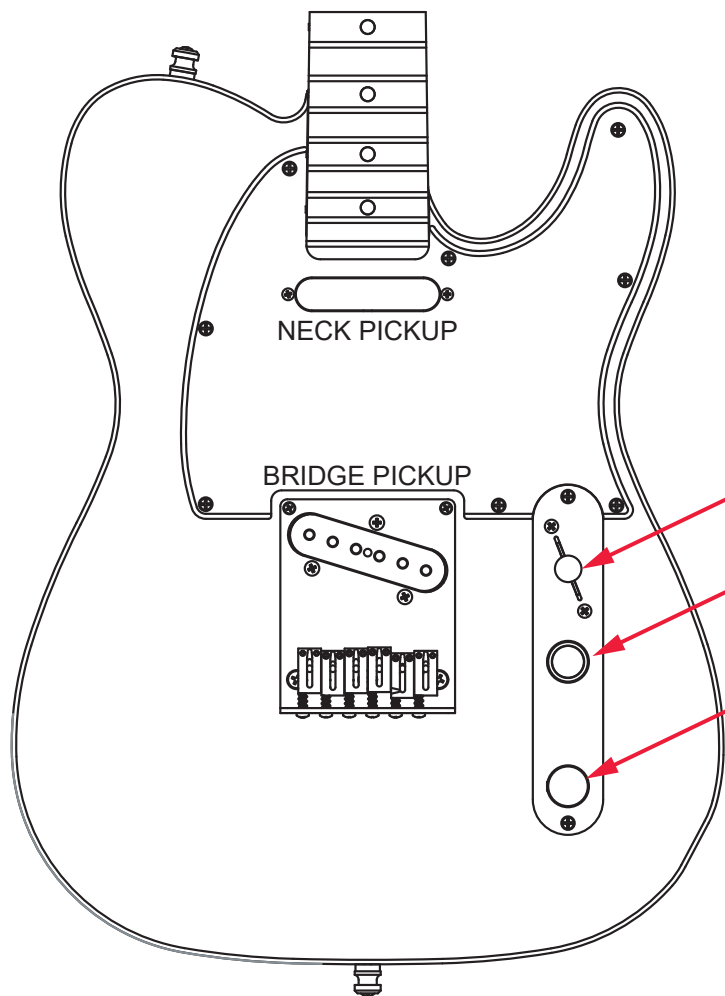

3-WAY SWITCH

VOLUME/S1 SWITCH

TONE CONTROL

AMERICAN ULTRA LUXE VINTAGE 60'S TELECASTER® (0118250XXX)

ADDITIONAL SPECIFICATION DETAIL

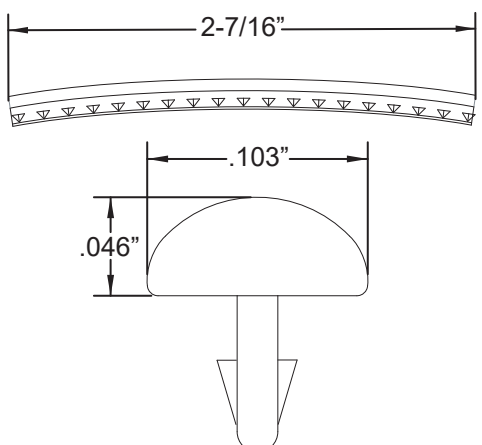
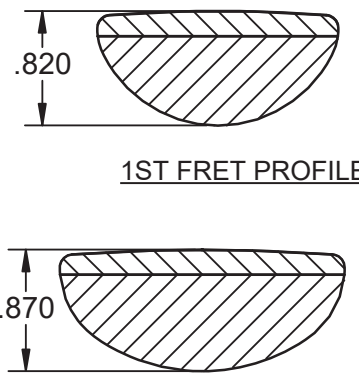
<p>FRET SIZE: MEDIUM JUMBO (FRET DIMENSIONS ARE BEFORE INSTALLATION)</p> 	<p>PLEASE NOTE: AS EACH NECK IS SANDED & FINISHED BY HAND, THICKNESS DIMENSIONS MAY VARY SLIGHTLY FROM THOSE SHOWN.</p>	<p>NECK PROFILE: MODERN "D"</p>  <p style="text-align: center;">1ST FRET PROFILE</p> <p style="text-align: center;">12TH FRET PROFILE</p>
---	---	---

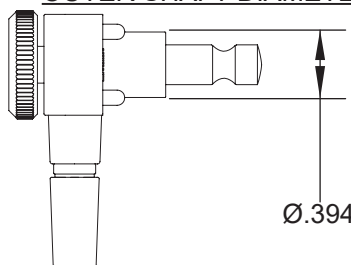
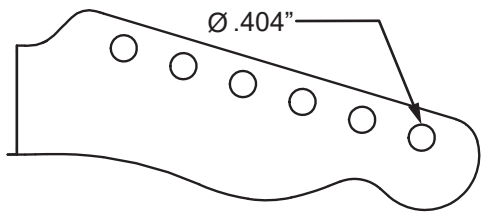
<p>TUNING MACHINES : P/N 7728723300 OUTER SHAFT DIAMETER .394"</p> 	<p>TUNING MACHINE THRU-HOLE INNER DIAMETER .404"</p> 
---	---

SADDLE HEIGHT ADJUSTMENT WRENCH:
.050" HEX KEY P/N 0018531049

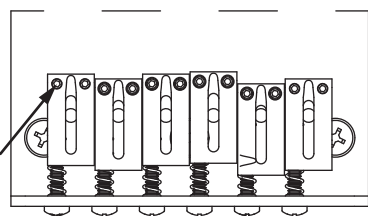

SADDLE HEIGHT ADJUSTMENT SCREWS:
TALL 3/8": P/N 0018027049 SHORT 5/16": P/N 0026780049

TRUSS ROD NUT P/N 0994943000
TRUSS ROD ADJUSTMENT WRENCH:
1/8" HEX KEY P/N 0023811049

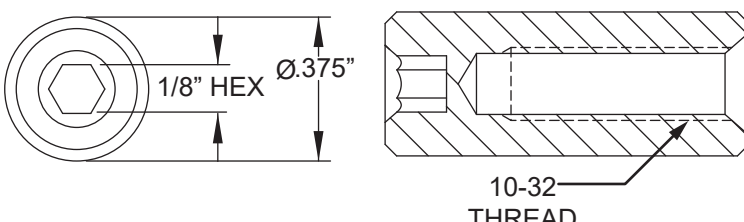

LOGO: AM ULTRA LUXE 60S TELE
APPLIED OVER THE FINISH



PICKUP SPECIFICATIONS			
POSITION	MAGNETS	DC RESISTANCE	POLARITY
NECK	ALNICO 5 BEVELED	6.6 - 8.1KΩ	SOUTH
-	-	-	-
BRIDGE	ALNICO 5 BEVELED	5.4 - 6.6KΩ	NORTH