

# AMERICAN ULTRA II STRATOCASTER® (011914XXXX)

## PARTS LAYOUT

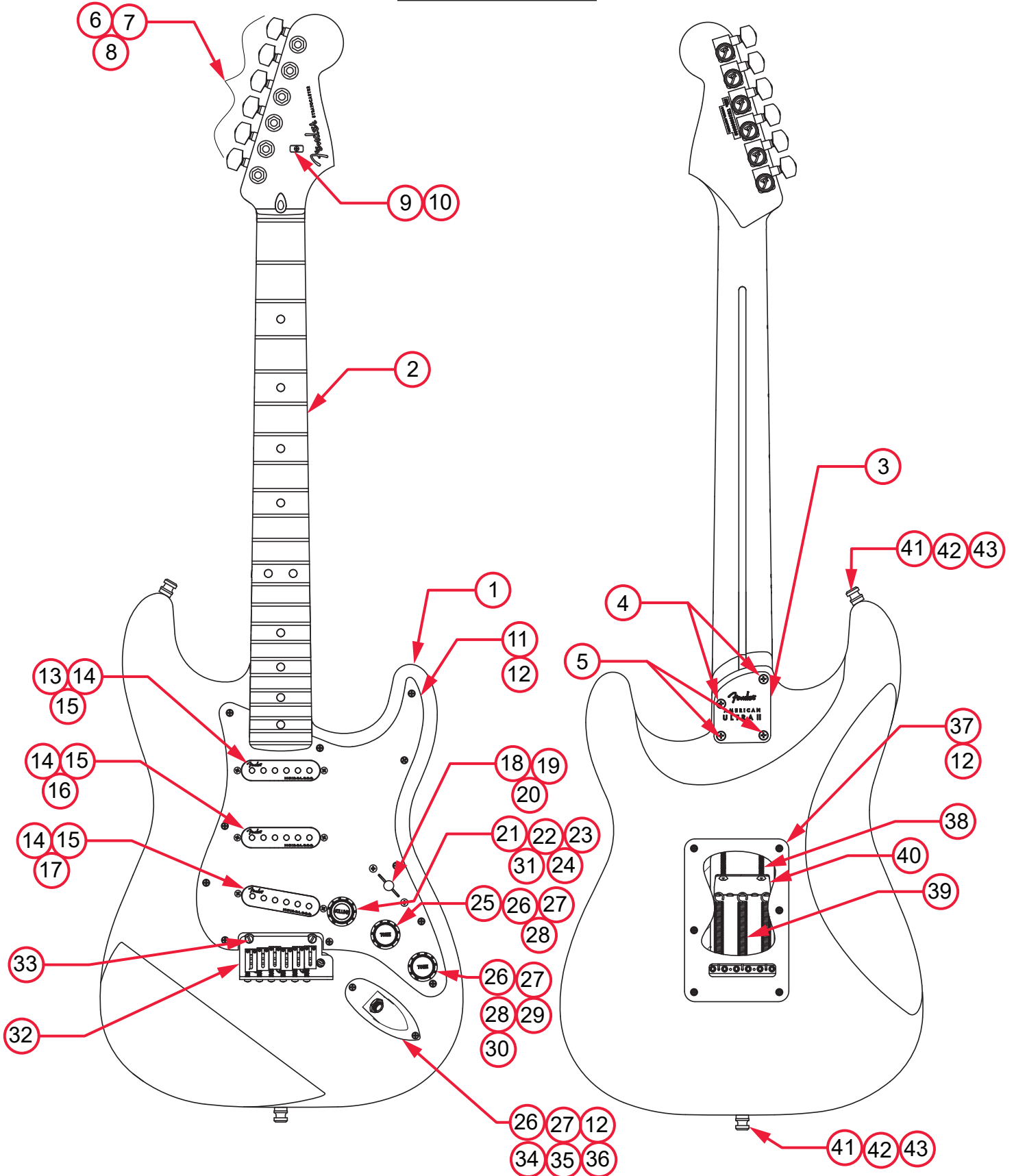

# AMERICAN ULTRA II STRATOCASTER® (011914XXXX)

## PARTS LIST

REF#	DESCRIPTION	PART NUMBER
1	BODY AM ULTRA II STRAT ULBST	7728136512
1	BODY AM ULTRA II STRAT NBL	7728135576
1	BODY AM ULTRA II STRAT TXT	7728135590
1	BODY AM ULTRA II STRAT SFL	7728135533
1	BODY AM ULTRA II STRAT AVL	7728135596
1	BODY AM ULTRA II STRAT SRD	7728135599
2	NECK ASSY AM ULTRA II STRAT EB	7728134000
2	NECK ASSY AM ULTRA II STRAT MPL	7728133000
3	NECK PLATE ULTRA II GTR CHR	7728167000
4	SCREW SMA 8 X 1-1/4 OHP NI	0072900000
5	SCREW SMA 8 X 1-1/2 OHP NI	7716272000
6	KEY LOCKING SHORT POST	7728723000
7	WASHER KEY	0053106049
8	BUSHING KEY	0058820049
9	STRING TREE AM ELITE GTR CHR/WHDWR	0992081000
10	SCREW SMA 2X 9/16 FHP NI	0051621000
11	PICKGUARD AM STD STRAT GLD ALUM ANOD	7729128000
11	PICKGUARD AM STD STRAT CLR ALUM ANOD	7729127000
11	PICKGUARD AM STD STRAT BLK ALUM ANOD	7729129000
12	SCREW SMAB 4 X 1/2 OHP NI	0015578049
13	PICKUP ASSY AM ULTRA II STRAT NK AGED WHT	7728138000
13	PICKUP ASSY AM ULTRA II STRAT NK PARCH	7728505000
13	PICKUP ASSY AM ULTRA II STRAT NK BLK	7728575000
14	TUBING SILICONE RUBBER .50 RED	0063398000
15	SCREW SPCL 4-40 X 13/16 BRASS #5 HEAD NI	0099474000
16	PICKUP ASSY AM ULTRA II STRAT MID AGED WHT	7728139000
16	PICKUP ASSY AM ULTRA II STRAT MID PARCH	7728506000
16	PICKUP ASSY AM ULTRA II STRAT MID BLK	7728576000
17	PICKUP ASSY AM ULTRA II STRAT BRDG AGED WHT	7728140000
17	PICKUP ASSY AM ULTRA II STRAT BRDG PARCH	7728507000
17	PICKUP ASSY AM ULTRA II STRAT BRDG BLK	7728577000
18	SWITCH 5-WAY LEVER DISCRETE/COM	0078776049
19	KNOB LEVER SWITCH AGED WHT	0994938000
19	KNOB LEVER SWITCH PARCH	0056253049
19	KNOB LEVER SWITCH BLK	0994939000
20	SCREW 6-32 X 5/8 RHP STL NI	0015800049

\*= NOT PICTURED IN DIAGRAM



# AMERICAN ULTRA II STRATOCASTER® (011914XXXX)

REF#	DESCRIPTION	PART NUMBER
21	SW/POT ASSY S-1 250K .25B SPSHW/HDWR	0078777049
22	KNOB STRAT SOFT OVERMOLD SPSH AGED WHT	7708070000
22	KNOB STRAT SOFT OVERMOLD SPSH PARCH	7708070040
22	KNOB STRAT SOFT OVERMOLD SPSH BLK	7708070020
23	SWITCH CAP STRAT SPSH VOLUME AGED WHT	0059266030
23	SWITCH CAP STRAT SPSH VOLUME PARCH	0059266040
23	SWITCH CAP STRAT SPSH VOLUME BLK	0059266020
24	PCB ASSY TREB BLEED AM PRO STRAT/TELE	7711092000
25	CONTROL 250K 10% TAPER SPSH	0078779000
26	WASHER LOCKING INTL 3/8 X .687 X .035	0016436049
27	NUT HEX 3/8-32 X 3/32 TK NI	0016352049
28	KNOB STRAT SOFT OVERMOLD TONE AGED WHITE	7708072000
28	KNOB STRAT SOFT OVERMOLD TONE PARCH	7708072040
28	KNOB STRAT SOFT OVERMOLD TONE BLK	7708072020
29	CONTROL 250K 10% SPSH NO LOAD	0078780000
30	CAPACITOR ORANGE DROP .022uF 100V 5%	7727719000
31	2-PIN MALE LOCKING QUICK CONNECT BW 4"	7717591000
32	BRIDGE ASSY AM ULTRA II STRAT RH CHR	7728834000
32A	BRIDGE PLATE ULTRA STRAT	0036527000
32B	BRIDGE BLOCK AM ULTRA II	7728836000
32C	SCREW MACH 8-32 X 3/8 FHP NI	0019656049
32D	BRIDGE SADDLE AM STD STRAT POLISHED	0036528000
32E	SCREW MACH 4-40 X 5/8 PHP BLX	0017031049
32F	SPRING 1/4 X .115 X .023 3-C BLX	0019395049
32F	SPRING 3/8 X .115 X .023 4-C BLX	0019394049
32G	SET SCREW 4-40 X 1/4 HEX CUP STL BLX	0026779049
32H	SET SCREW 4-40 X 5/16 HEX CUP STL BLX	0026778049
32I	SET SCREW 10-32 X 1/8 HEX SKT FP BLX	7710985000
32J	SPRING CLIP ULTRA	0036531000
32K	BUSHING NYLON BLK .310D X .221ID X .87L	0036614000
33	PIVOT POST ASSY	0093273000
34	FERRULE JACK CHR	0991940100
35	JACK PHONE OPEN CIRCUIT	0021956049
36	2-PIN FEMALE LOCKING QUICK CONNECT BW 6"	7717592000

\*= NOT PICTURED IN DIAGRAM









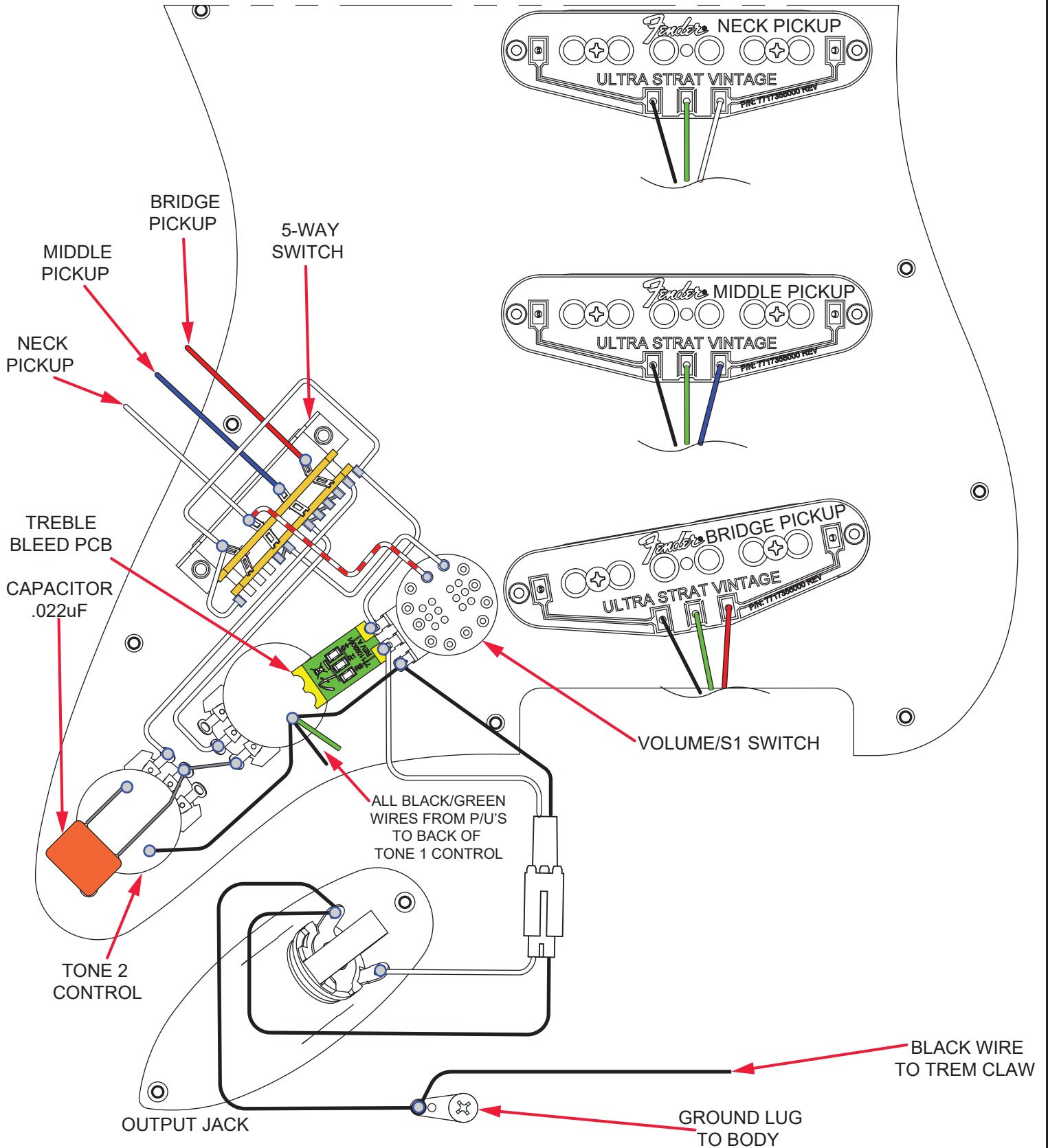















# AMERICAN ULTRA II STRATOCASTER® (011914XXXX)

## WIRING ASSEMBLY

























# AMERICAN ULTRA II STRATOCASTER® (011914XXXX)

## SWITCH AND CONTROL FUNCTION

TONE CONTROL	T1 ONLY	T1 ONLY	T1 ONLY	T1 ONLY	T2 ONLY	
5 WAY SELECTOR POSITION						S-1 SWITCH OFF (UP POSITION)
NECK PICKUP						COMBINED PICKUPS ARE IN PARALLEL
MIDDLE PICKUP						
BRIDGE PICKUP						

TONE CONTROL	T1 ONLY	T1 ONLY	T1 ONLY	T1 ONLY	T2 ONLY	
5 WAY SELECTOR POSITION						S-1 SWITCH ON (DOWN POSITION)
NECK PICKUP						COMBINED PICKUPS ARE IN PARALLEL
MIDDLE PICKUP						
BRIDGE PICKUP						

 PICKUP IS ON    
  PICKUP IS OFF

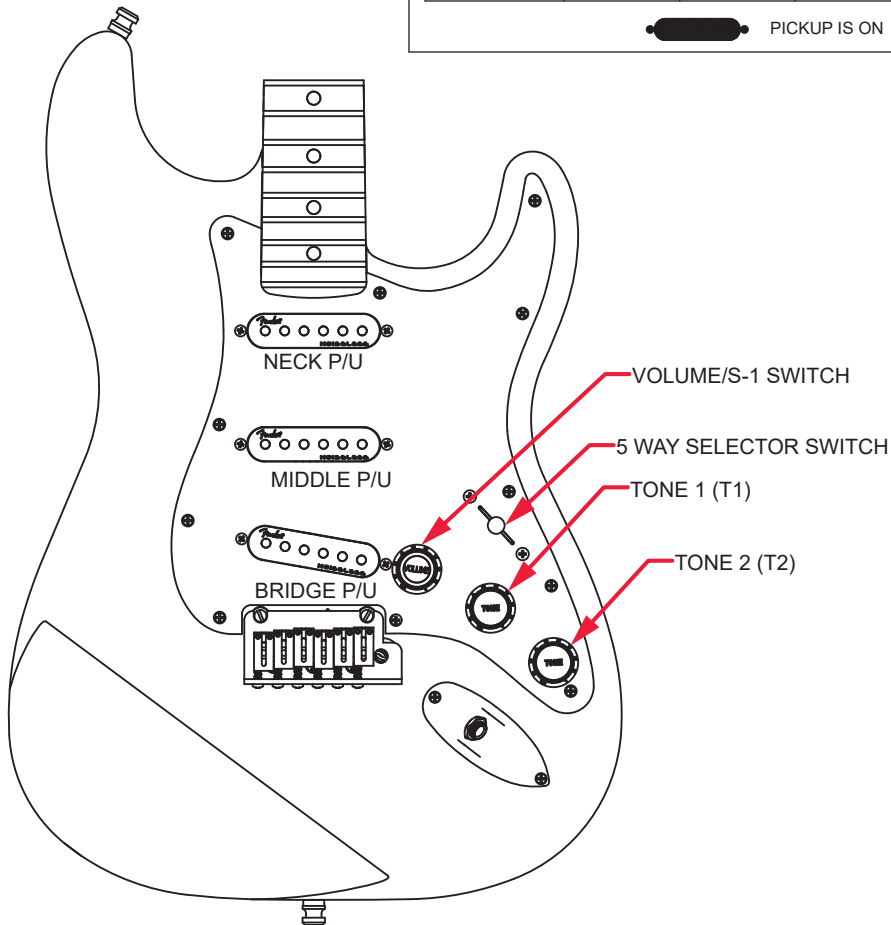

# AMERICAN ULTRA II STRATOCASTER® (011914XXXX)

## ADDITIONAL SPECIFICATION DETAIL

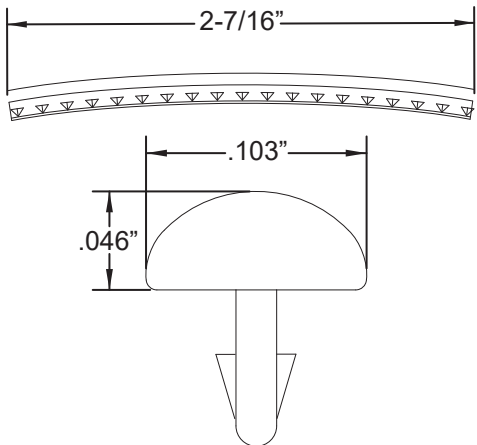
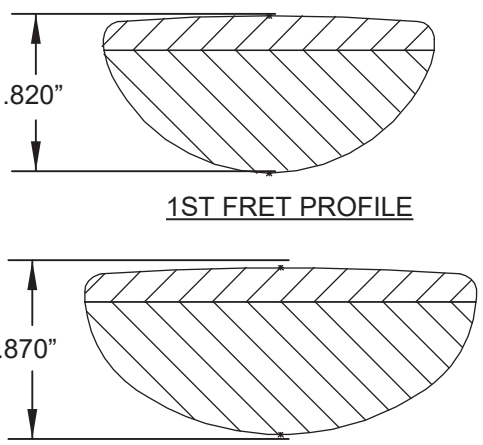
<p><b>FRET SIZE: MEDIUM JUMBO</b> (FRET DIMENSIONS ARE BEFORE INSTALLATION)</p> 	<p>PLEASE NOTE: AS EACH NECK IS SANDED &amp; FINISHED BY HAND, THICKNESS DIMENSIONS MAY VARY SLIGHTLY FROM THOSE SHOWN.</p>	<p><b>NECK PROFILE: ULTRA MODERN "D"</b></p>  <p style="text-align: center;"><b>1ST FRET PROFILE</b></p> <p style="text-align: center;"><b>12TH FRET PROFILE</b></p>
---	---	---

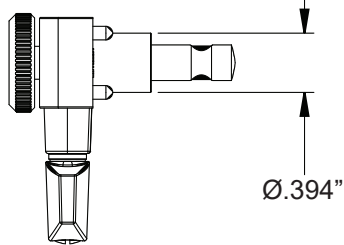
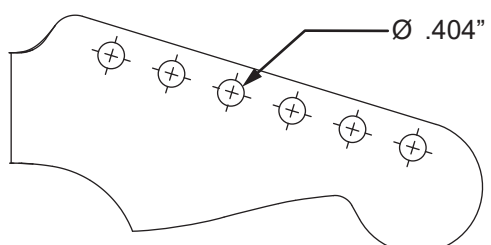
<p><b>TUNING MACHINES: P/N 7728723000</b> <b>OUTER SHAFT DIAMETER .394"</b></p> 	<p><b>TUNING MACHINE THRU-HOLE</b> <b>INNER DIAMETER .404"</b></p> 
--	---

**SADDLE HEIGHT ADJUSTMENT WRENCH:**  
**.050" HEX KEY P/N 0018531049**

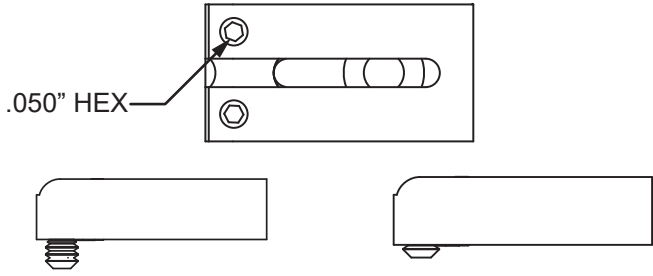

**SADDLE HEIGHT ADJUSTMENT SCREWS:**  
TALL: P/N 0026778049    SHORT: P/N 0026779049

**TRUSS ROD NUT P/N 0994943000**  
**TRUSS ROD ADJUSTMENT WRENCH:**  
**1/8" HEX KEY P/N 0023811049**

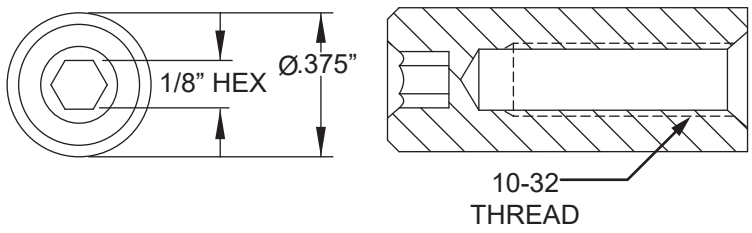

**10-32  
THREAD**

**LOGO: AM ULTRA STRAT DECAL GOLD CHROME**  
**APPLIED UNDER THE FINISH**



<b>PICKUP SPECIFICATIONS</b>			
POSITION	MAGNETS	DC RESISTANCE	POLARITY
NECK	ALNICO 5 UNBEVELED	8.6 - 9.4KΩ	NORTH
MIDDLE	ALNICO 5 UNBEVELED	8.7 - 9.7KΩ	SOUTH
BRIDGE	ALNICO 5 UNBEVELED	10.7 - 11.5KΩ	NORTH

