

AMERICAN ULTRA II TELECASTER® (011917XXXX)

PARTS LAYOUT

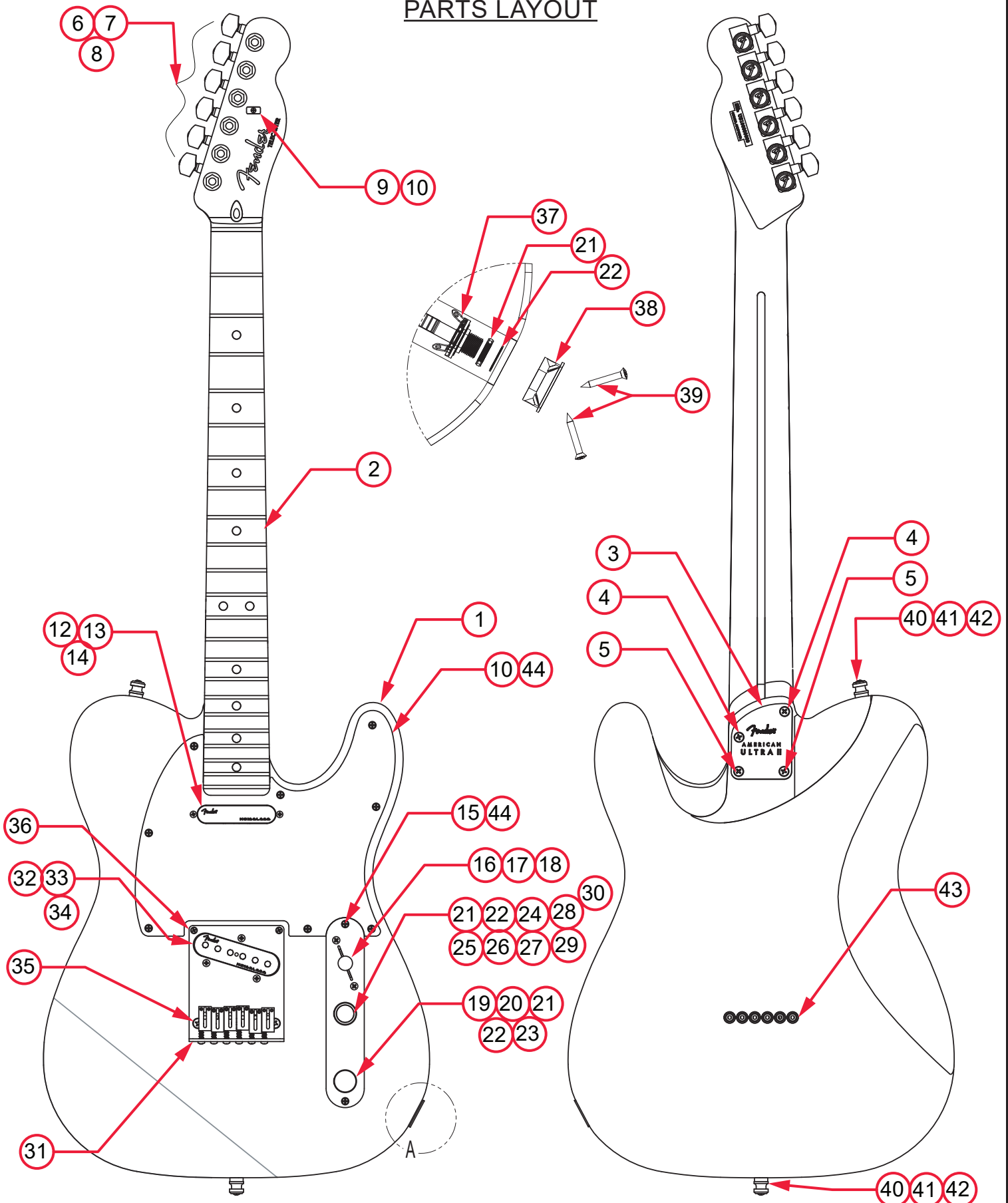

AMERICAN ULTRA II TELECASTER® (011917XXXX)

PARTS LIST

REF#	DESCRIPTION	PART NUMBER
1	BODY AM ULTRA II TELE ALD SFL	7728237533
1	BODY AM ULTRA II TELE ALD ULBST	7728239512
1	BODY AM ULTRA II TELE ALD AVL	7728237596
1	BODY AM ULTRA II TELE ALD SRD	7728237599
1	BODY AM ULTRA II TELE ALD TXT	7728237590
2	NECK ASSY AM ULTRA II TELE EBY	7728240000
2	NECK ASSY AM ULTRA II TELE MPL	7728241000
3	NECK PLATE ULTRA II GTR CHR	7728167000
4	SCREW SMA 8 X 1-1/4 OHP NI	0072900000
5	SCREW SMA 8 X 1-1/2 OHP NI	7716272000
6	KEY LOCKING SHORT POST	7728723000
7	WASHER KEY	0053106049
8	BUSHING KEY	0058820049
9	STRING TREE AM ELITE GTR CHR/WHDWR	0992081000
10	SCREW SMA 2X 9/16 FHP NI	0051621000
11	PICKGUARD AM ULTRA II TELE CLR ANOD	7729134000
11	PICKGUARD AM ULTRA II TELE GLD ANOD	7729135000
11	PICKGUARD AM ULTRA II TELE BLK ANOD	7729136000
12	PICKUP ASSY N4 ULTRA II TELE NK VINT	7728247000
13	SCREW MACH 4-40 X 7/8 RHP STL NI	7700222000
14	TUBING SILICONE RUBBER .688 RED	7709812000
15	CONTROL PLATE TELE ANGLE SWITCH CHR	7719173000
16	SWITCH 3-WAY LEVER	0992041100
17	SCREW MACH 6-32 X 5/8 RH NI	0021417049
18	KNOB SWITCH TELE W/NYLON INSERT BLK	7728973000
19	KNOB HEAVY DIAMOND KNURL CHR	0096227000
20	CONTROL 250K 10% TAPER NO LOAD SOSH	0078782049
21	NUT HEX 3/8-32 X 3/32 TK NI	0016352049
22	WASHER LOCKING INTL 3/8 X .687 X .035 NI	0016436049
23	CAPACITOR ORANGE DROP .022uF 100V 5%	7727719000
24	TELE/P-BASS SWITCH KNOB HEAVY KNURL CHR	0096224000
25	TELE/P-BASS SWITCH CAP CHROME	0059270000
26	SW/POT ASSY S-1 250K .25B SOSH	0078979049
27	COUPLING SLEEVE SOSH .320	0059278049
28	PCB ASSY TREBLE BLEED AM PRO STRAT/TELE	7711092000

*= NOT PICTURED IN DIAGRAM







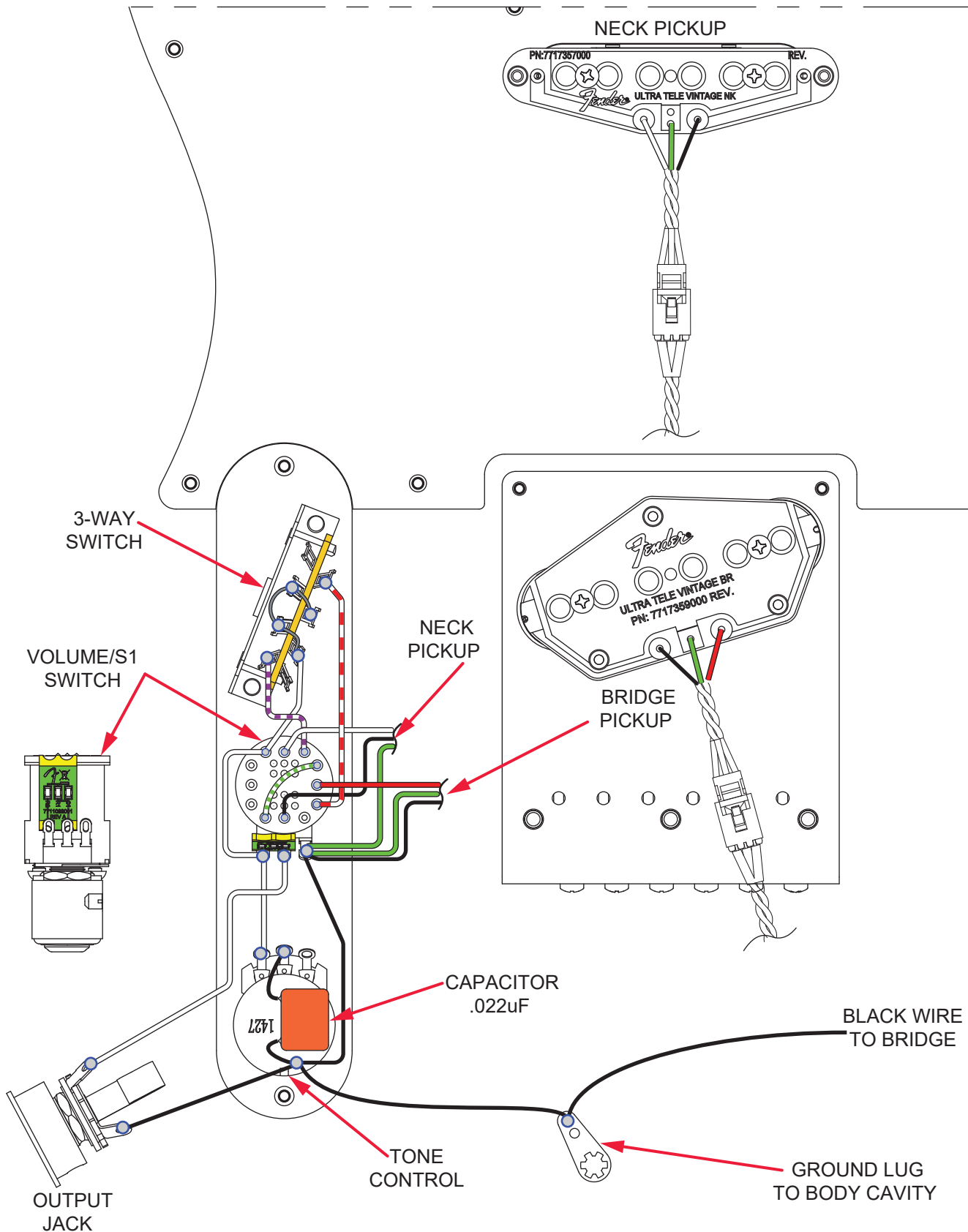



AMERICAN ULTRA II TELECASTER® (011917XXXX)

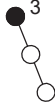

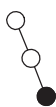
WIRING ASSEMBLY





AMERICAN ULTRA II TELECASTER® (011917XXXX)

SWITCH AND CONTROL FUNCTION

3 WAY SWITCH POSITION, S-1 OFF			
			3 WAY SWITCH
			NECK PICKUP
	IN PARALLEL 		BRIDGE PICKUP

3 WAY SWITCH BYPASSED S-1 ON DOWN POSITION	
	NECK PICKUP
IN SERIES 	BRIDGE PICKUP

	PICKUP IS ON
	PICKUP IS OFF

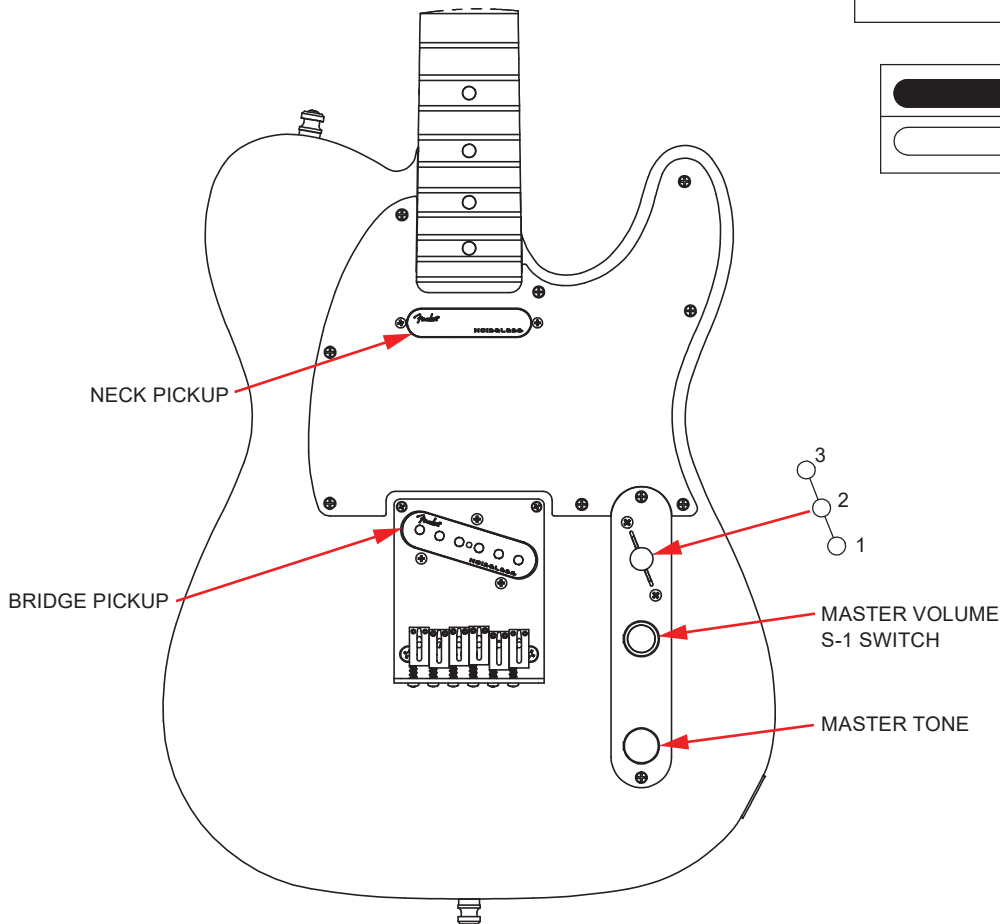

AMERICAN ULTRA II TELECASTER® (011917XXXX)

ADDITIONAL SPECIFICATION DETAIL

FRET SIZE: MEDIUM JUMBO
(FRET DIMENSIONS ARE BEFORE INSTALLATION)

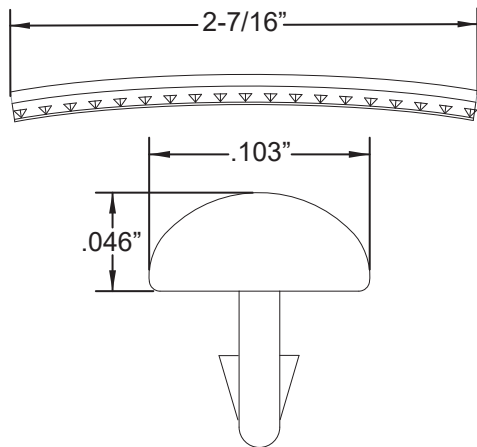

PLEASE NOTE: AS EACH NECK IS SANDED & FINISHED BY HAND, THICKNESS DIMENSIONS MAY VARY SLIGHTLY FROM THOSE SHOWN.

NECK PROFILE: MODERN "D"

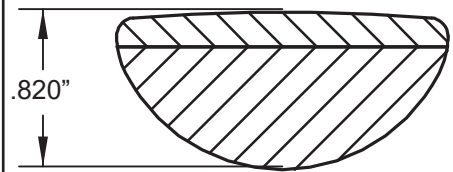

1ST FRET PROFILE

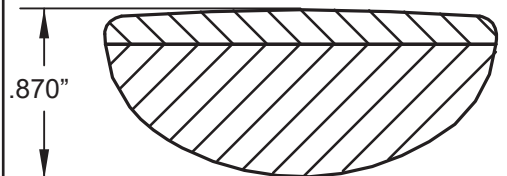

12TH FRET PROFILE

TUNING MACHINES: P/N 7728723000
OUTER SHAFT DIAMETER .394"

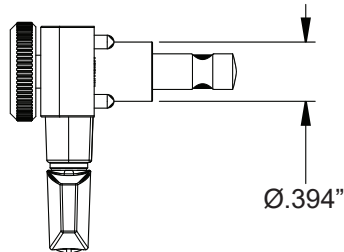

TUNING MACHINE THRU-HOLE
INNER DIAMETER .404"

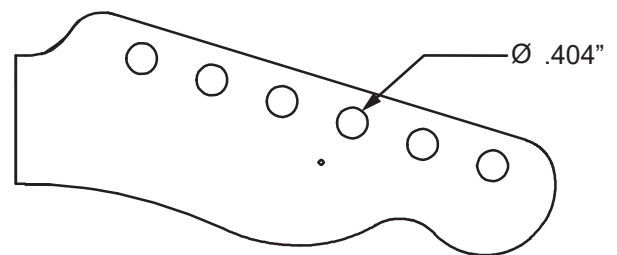

SADDLE HEIGHT ADJUSTMENT WRENCH:
.050" HEX KEY P/N 0018531049

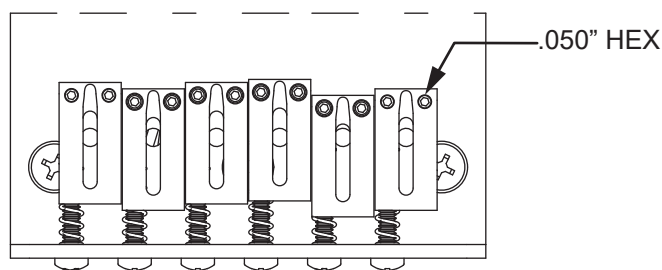

SADDLE HEIGHT SET SCREWS

3/8": P/N 0018027049

5/16": P/N 0026780049

TRUSS ROD NUT P/N 0994943000
TRUSS ROD ADJUSTMENT WRENCH:
1/8" HEX KEY P/N 0023811049

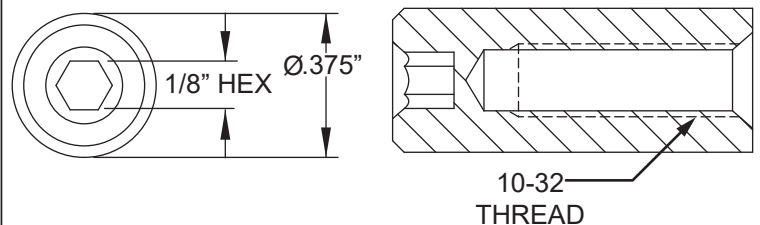

LOGO: AMERICAN ULTRA TELE
APPLIED UNDER THE FINISH



PICKUP SPECIFICATIONS

POSITION	MAGNETS	DC RESISTANCE	POLARITY
NECK	ALNICO 5 UNBEVELED	10.73 - 11.41KΩ	NORTH
BRIDGE	ALNICO 5 UNBEVELED	10.58 - 11.23KΩ	SOUTH