

JACK WHITE TRIPLECASTER (0176812706)

PARTS LAYOUT

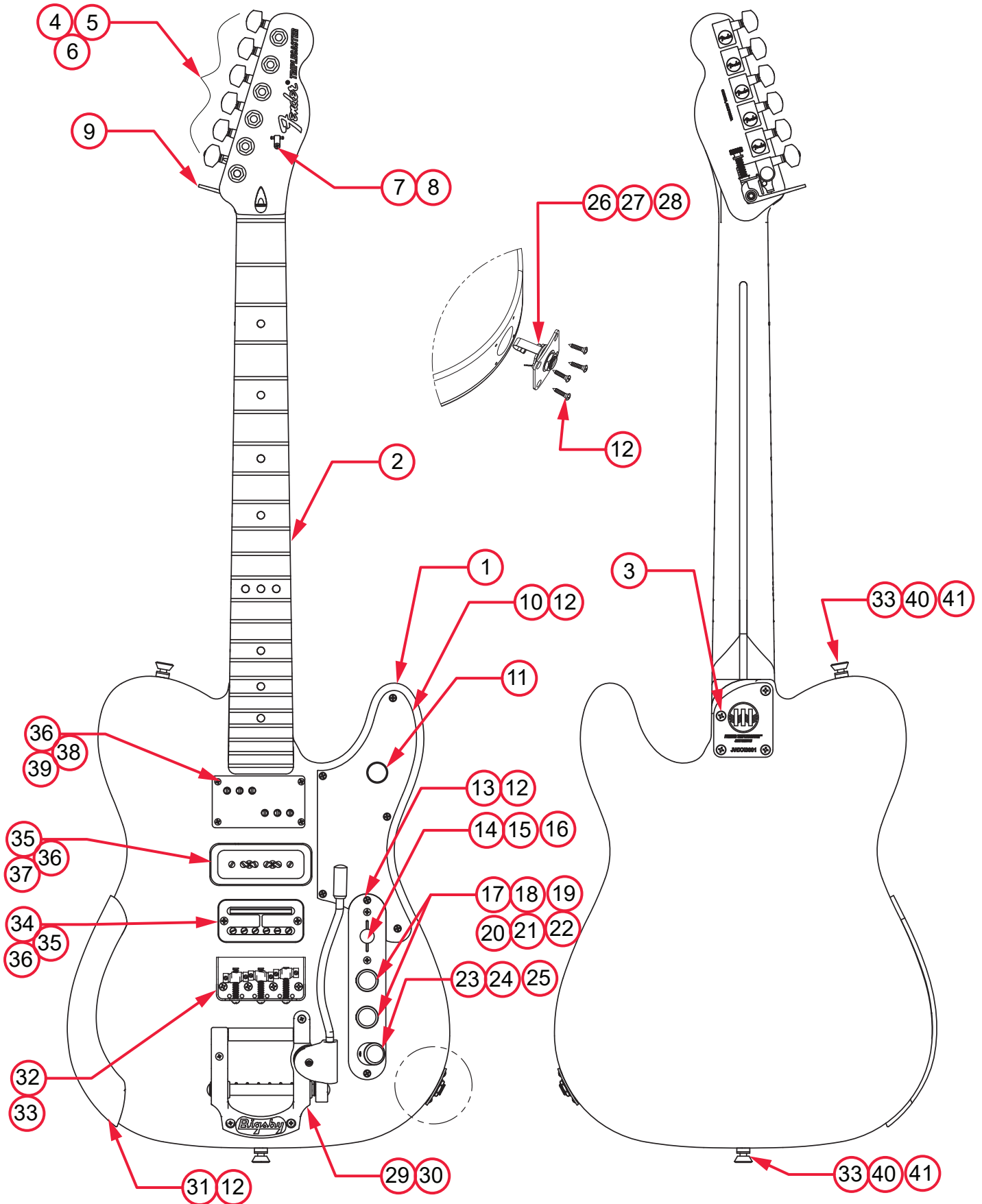

JACK WHITE TRIPLECASTER (0176812706)

PARTS LIST

REF#	DESCRIPTION	PART NUMBER
1	BODY JACK WHITE TRIPLECASTER WHT	7727964506
2	NECK ASSY JACK WHITE TRIPLECASTER	7727966000
3	SCREW SMAB 8 X 1-3/4 OHP NI	0015636049
4	KEY SET GTR DUAL PIN MTG CHR W/WPC BUT	7727979000
5	WASHERS KEY	0053106049
6	BUSHINGS KEY	0058820049
7	STRING GUIDE TREE AM STD MATTE WPC	0021537080
8	SCREW SMAB 3 X 3/8 RHP STL NI	0011357049
9	KEY EXTENDER GTR CHR/WPC BUT HIPSHOT	7727980000
10	PICKGUARD JACK WHITE TRIPLECASTER WHT	7727969000
11	PUSH SWITCH WITH LED BLK	7727970000
12	SCREW SMAB 4 X 1/2 OHP NI	0015578049
13	CONTROL PLATE JACK WHITE TRIPLECASTER	7727972000
14	SWITCH 3-WAY LEVER	0038993049
15	SCREW MACH 6-32 X 5/8 RH NI	0994925000
16	KNOB SWITCH TELE W/NYLON INSERT WHT	7729705000
17	CONTROL SOSH 500K A-TAPER .25B .625S	0079409000
18	WASHER LOCKING INTL 3/8 X .687 X .035 NI	0016436049
19	NUT HEX 3/8-32 X 3/32 TK NI	0016352049
20	KNOB NOCASTER MATTE WHT POWDER COAT	0058085080
21	SET SCREW SLOTTED 8-32 X 3/16 NI	0994922000
22	CAPACITOR MPF RDL .022uF 250V 10%	0024832049
23	SWITCH TOGGLE 3-WAY 4PDT ON-ON-ON	7728738000
24	TOGGLE ADAPTER SLEEVE NOCASTER KNOB	7728683000
25	KNOB JACK WHITE TRIPLECASTER WPC	7728737000
26	JACK PLATE SQUARE WPC	9280520080
27	JACK PHONE OPEN CIRCUIT 11	0021956049
28	WASHER FLAT 3/8 X .614 NI	0031153049
29	BIGSBY B5 ATKINS 8" ARM WPC	7727975000
30	SCREW WOOD 6 X 1 OHP NI	0016188049
31	ARM REST JACK WHITE TRIPLECASTER	7727978000
32	BRIDGE ASSY JACK WHITE TRIPLECASTER	7727974000
33	SCREW SMA #6 X 1 OHP NI	0037958049

*= NOT PICTURED IN DIAGRAM







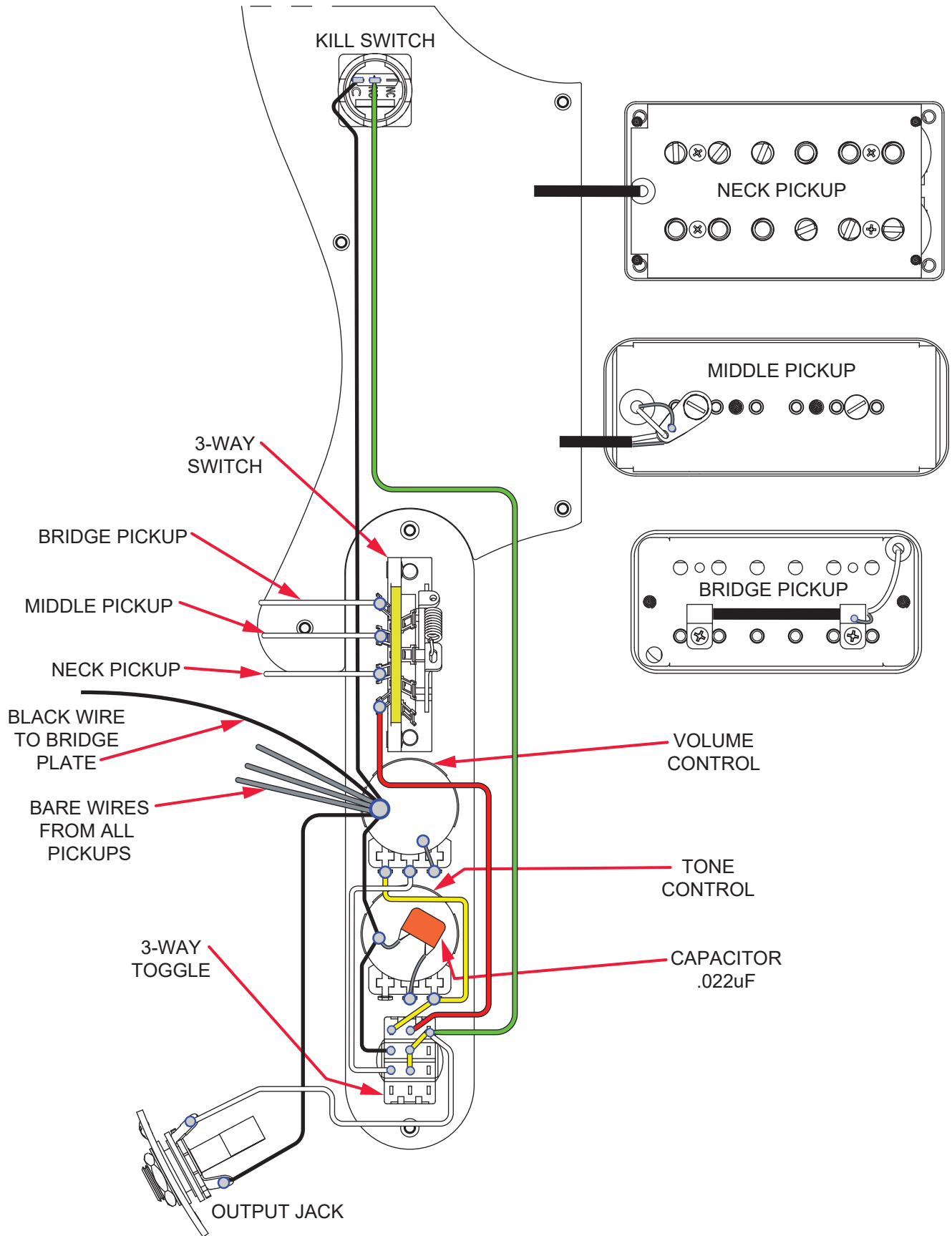







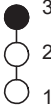

JACK WHITE TRIPLECASTER (0176812706)

WIRING ASSEMBLY

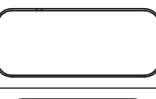

JACK WHITE TRIPLECASTER (0176812706)

SWITCH AND CONTROL FUNCTION

PICKUP OFF  PICKUP ON 	3-WAY SWITCH FUNCTION			POSITION	
					
					NECK PICKUP
					MIDDLE PICKUP
					BRIDGE PICKUP

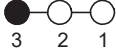
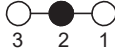
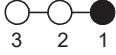
3-WAY TOGGLE FUNCTION		
		
KILL SWITCH (NO SOUND)	3-WAY SWITCHING WITH MASTER VOLUME AND MASTER TONE ACTIVE	STRAIGHT TO OUTPUT. MASTER VOLUME AND MASTER TONE BYPASSED. 3-WAY SWITCHING ACTIVE

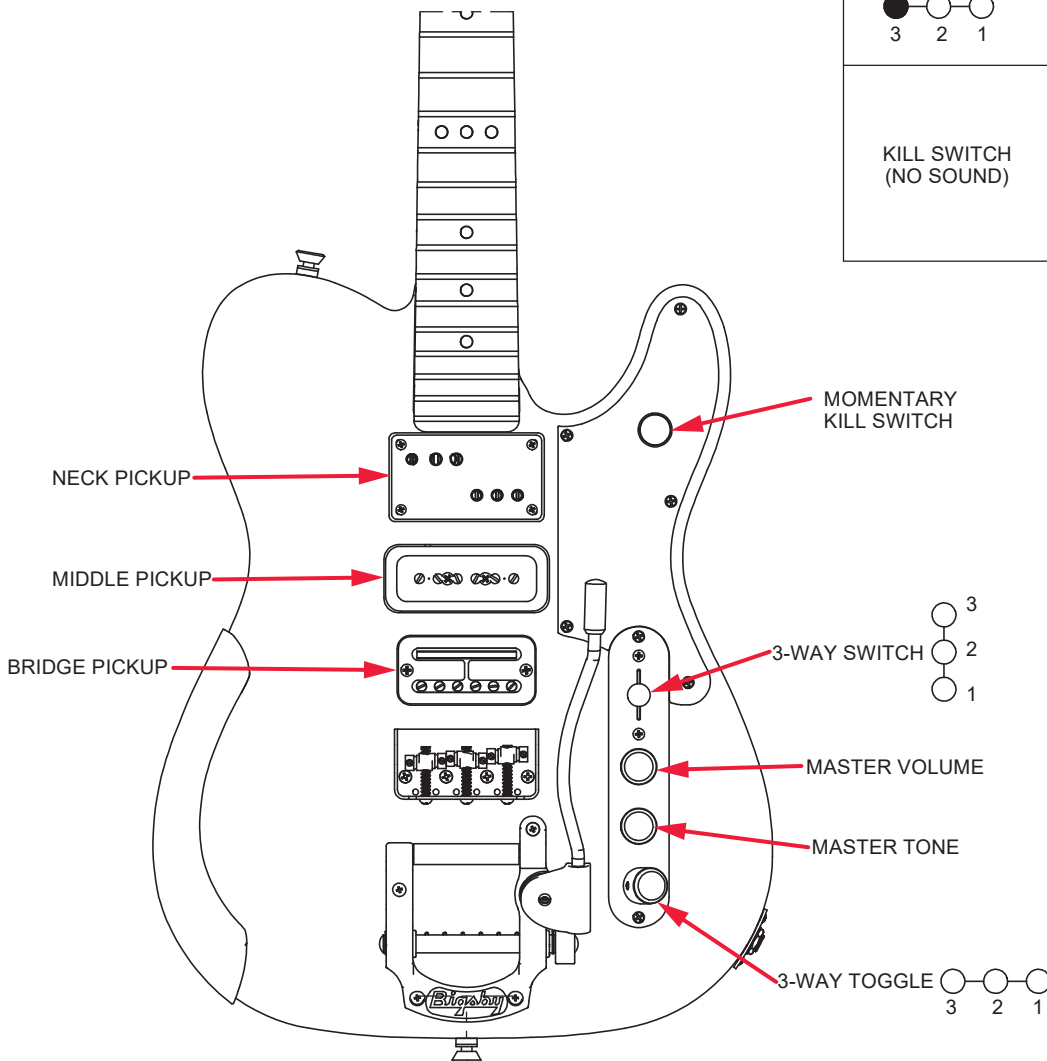

JACK WHITE TRIPLECASTER (0176812706)

ADDITIONAL SPECIFICATION DETAIL

FRET SIZE: MEDIUM JUMBO
(FRET DIMENSIONS ARE BEFORE INSTALLATION)

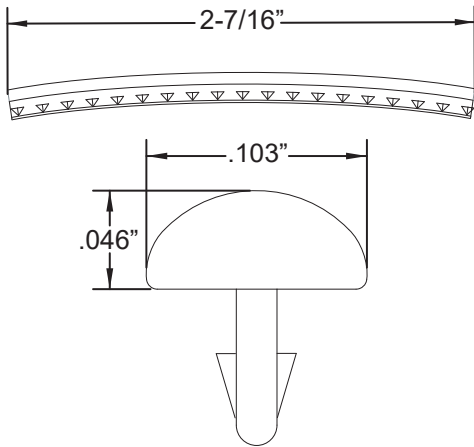

PLEASE NOTE: AS EACH NECK IS SANDED & FINISHED BY HAND, THICKNESS DIMENSIONS MAY VARY SLIGHTLY FROM THOSE SHOWN.

NECK PROFILE: JACK WHITE SOFT "V"

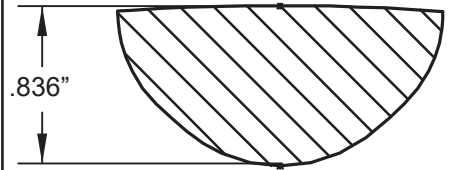

1ST FRET PROFILE

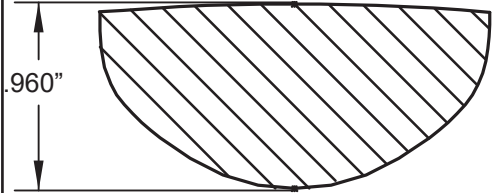

12TH FRET PROFILE

TUNING MACHINES : P/N 7727979000
OUTER SHAFT DIAMETER .394"

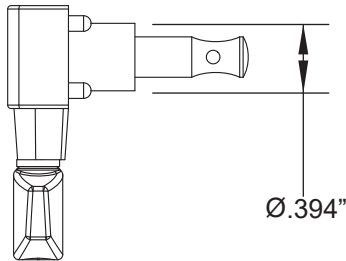

TUNING MACHINE THRU-HOLE
INNER DIAMETER .404"

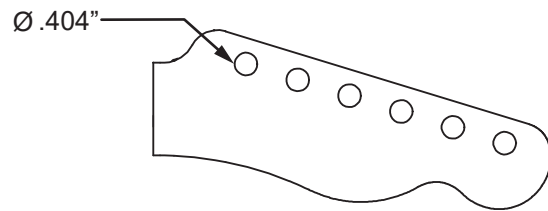

SADDLE HEIGHT ADJUSTMENT WRENCH:
1/16" HEX KEY P/N 0021109049

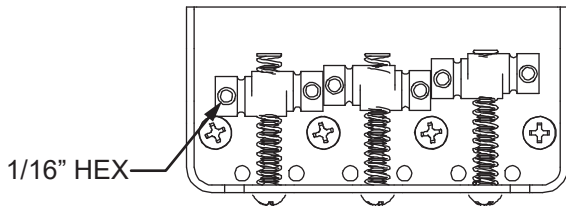

TRUSS ROD NUT P/N 0994943000
TRUSS ROD ADJUSTMENT WRENCH:
1/8" HEX KEY P/N 0023811049

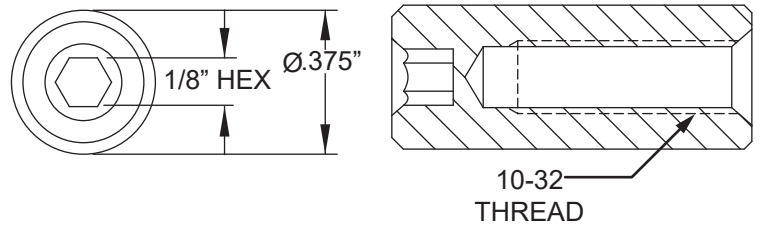

LOGO: JACK WHITE TRIPLECASTER
APPLIED UNDER THE FINISH



PICKUP SPECIFICATIONS

POSITION	MAGNETS	DC RESISTANCE	POLARITY
NECK	CUNIFE	7.76 - 8.24KΩ	SOUTH NORTH
MIDDLE	ALNICO 4 BAR	8.54 - 9.06KΩ	NORTH
BRIDGE	ALNICO 2 BAR	5.3 - 7.6KΩ	NORTH SOUTH